

MelTrax

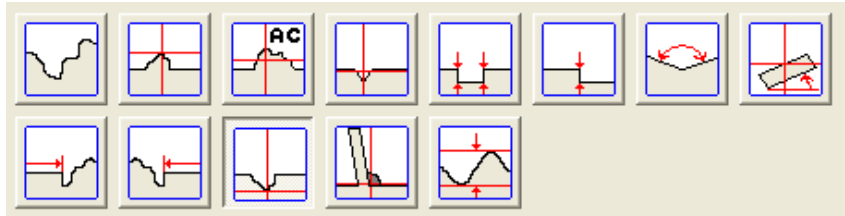

Software for SeamTracking Version 2.4.2

Software Manual English Version



MEL Mikroelektronik GmbH
Breslauer Str. 2, D-85386 Eching / Germany
Tel: + 49 – 89 – 327 150 – 0
Fax: + 49 – 89 – 319 20 23
info@MELsensor.de
© Copyright MEL 2008-2010

Content

- Version information..... 3
- Introduction..... 4
- MelTrax Software Features 4
- Structure of MelTrax Software 4
- Encoder 5
- VScanner..... 5
- TCP-Client..... 5
- Profibus-Client..... 5
- CANbus-Client (planned)..... 5
- Display-Client 6
- Analog Client 6
- Selection Client..... 6
- Relay/Digital I/O-Client 6
- Signal Output Options 7
- The main screen User Interface 7
- Measurement: Select Algorithm..... 8
 - Simple GUI 8
 - Technical support, algorithms and mathematical methods..... 8
 - Select measurement algorithm 9
 - 0 Profile display 10
 - 1 Profile – highest point 10
 - 2 Profile – highest point + Area Centroid (weighted) 11
 - 3 Seam Tracking 11
 - 4 Groove depth | Groove width | Position 12
 - 5 Edge | Step height | Position 13
 - 6 X-Angle..... 14
 - 7 Position + slope 15
 - 8 / 9 Left Edge and Right Edge seam tracking 15
 - 10 Deepest point (Min Height) 16
 - 11 Fillet weld..... 17
 - 12 Amplitude..... 20
 - Zoom 21
 - Scanner Parameters..... 22
 - Settings 23
 - Configuration Set No 24
 - Show Center Line | Show Set point Area..... 24
 - Activate video refresh 24
 - Minimize at Start..... 24
 - Low Performance Mode 24
 - Dynamic averaging and dynamic system behaviour..... 24
 - Search depth 24
 - Filter depth..... 24
 - P-Plausibility, S-Plausibility..... 24
 - Dynamic Filters: Noise Reduction, S-Filter, Smoothing..... 24
 - Display control..... 25
 - DSS / Distance on Edge..... 25
 - Activate video refresh 25
 - TP/W in Groove 25
 - Z-Mirror..... 26
 - Invert-X; Invert-Z..... 26
 - Find Pivot Angle 26
 - Rotate Scan..... 26
 - Auto Rotate..... 26
 - Reset default Scanner settings..... 27
 - Optimize Performance..... 27
 - Selection Client..... 27
- Interface 28
 - Buffer..... 29
 - Auto Clear Buffer 29
 - Integration filter..... 29
- TCP Client 30
 - Settings 31
 - The Command line interface..... 31
 - Registration and unlocking 43

VScanner.....	44
Launch VScanner.....	44
File Player.....	44
Info	45
Driver.....	45
Connection Status	45
Network settings	45
Localhost	45
MEL Software and VScanner	46
Display Client.....	47
Analog Client	49
Profibus Client	50
Profibus-Interface	51
Environmental conditions.....	52
Protection from arc and sputter	52
Maintenance of the Laser-Scanners.....	52
Trouble Shooting	53
Installation	54
Hardware requirements	54
Software requirements	54
„Installation“ of MelTrax Software.....	54
MelTrax Clients, upbringing and care	57
Converter.....	57
Configuration	59
Xconfig.ini.....	59
EthernetScanner.ini.....	61
Connect MEL- Hardware	64
Definition of measurement.....	64
Tracking point and Setpoint.....	64
Variations of Hardware- and Software Configuration of MelTrax.....	65
Data communication to MelTrax clients.....	65
Customer specific clients.....	65
Changes and additions by software version	70

Version information

Version numbers

MelTrax	2.4.1	VScanner	0.9.9	selection client 1.0.0
TCP-Client	1.2.2	DisplayClient	1.0.6	
Profibus-Client	1.0.6	NG-Client	1.0.1	

Copyright: MEL GmbH, 2008-2010 / Hallbergmoos, 18.th July 2010

Disclaimer

This documentation has been written according to intense testing of the MelTrax software revision. Nevertheless MEL can not make warranties that MelTrax Software is free from bugs.

In order to resolve problems or malfunctions of your application contact MEL for further assistance with a detailed report.



Recommended literature:

Hardware manual for M2-LAN-Scanner	HB-M2D-Ethernet-E.pdf
Hardware manual for M2-iLAN-Scanner	HB-M2-iLAN-E.pdf
Catalog for M2D-Scanner :	KAT-komplett M2D-E.pdf
Hardware manual for the MEL iPC:	HB-IPC-Installation-E.pdf

For details on networking please read the *MEL networking tutorial* TE-network-E.pdf



Typing errors may occur; -)

Please feel free to send your feedback for further improvement of this documentation to the editor: r.kutzner@melsensor.de

Supported hardware: Laptop, desktop PC, industrial PC or M2-iControl
M2D / M2DW-Laser-Scanner models
M2D-LAN-Laser-Scanner models
M2-iLAN-Laser-Scanner models
For network connection, the PC should be equipped with appropriate network connections.

Introduction

MelTrax Software is a simple to use and highly versatile application Software for control of automated industrial systems for welding applications and tooling machines.

The software reads the scan profiles from the M2-Laser Scanner and controls the motor to keep the machine always in best position for the process. Special algorithms can be selected from the interface according to the geometry of the object.

MelTrax as a demo version is fully functional on screen. As a demo or evaluation version, MelTrax has no outputs from the Algorithms to the periphery like Profibus or TCP Clients. Output data must be unlocked with an electronic key on basis of a software license. In the demo version, all algorithms are working, and do show results on screen yet the inputs and outputs to interfaces like TCP Client, Profibus Client or RS-232 Client are disabled. When MelTrax is registered and unlocked, the headline of the program window shows "licensed to ...". The license is bound to the hardware of the PC. When you use MelTrax on another PC, you will need a new licensing key. For details on unlocking see **page 42**.

MelTrax Software Features

Measurement window	online profile display, status display, result display
Configuration	adjustment of M2D-Scanner Parameters: shutter time, Laser-Intensity, IP-Address, limits
Data filter	filters for suppression of unwanted signals
Outputs	<u>Depending from selected algorithm:</u> Seam position (Centre / Tracking point), Distance, right height /left height, area centre Width, height difference, seam height, angle Status, Laser-Intensity

Structure of MelTrax Software

The MelTrax Software has *MelTrax.exe* (start.exe) as main application and the „Clients“. MelTrax is installed on one PC; the Clients may be installed on the same PC or on *other* PCs in the network.

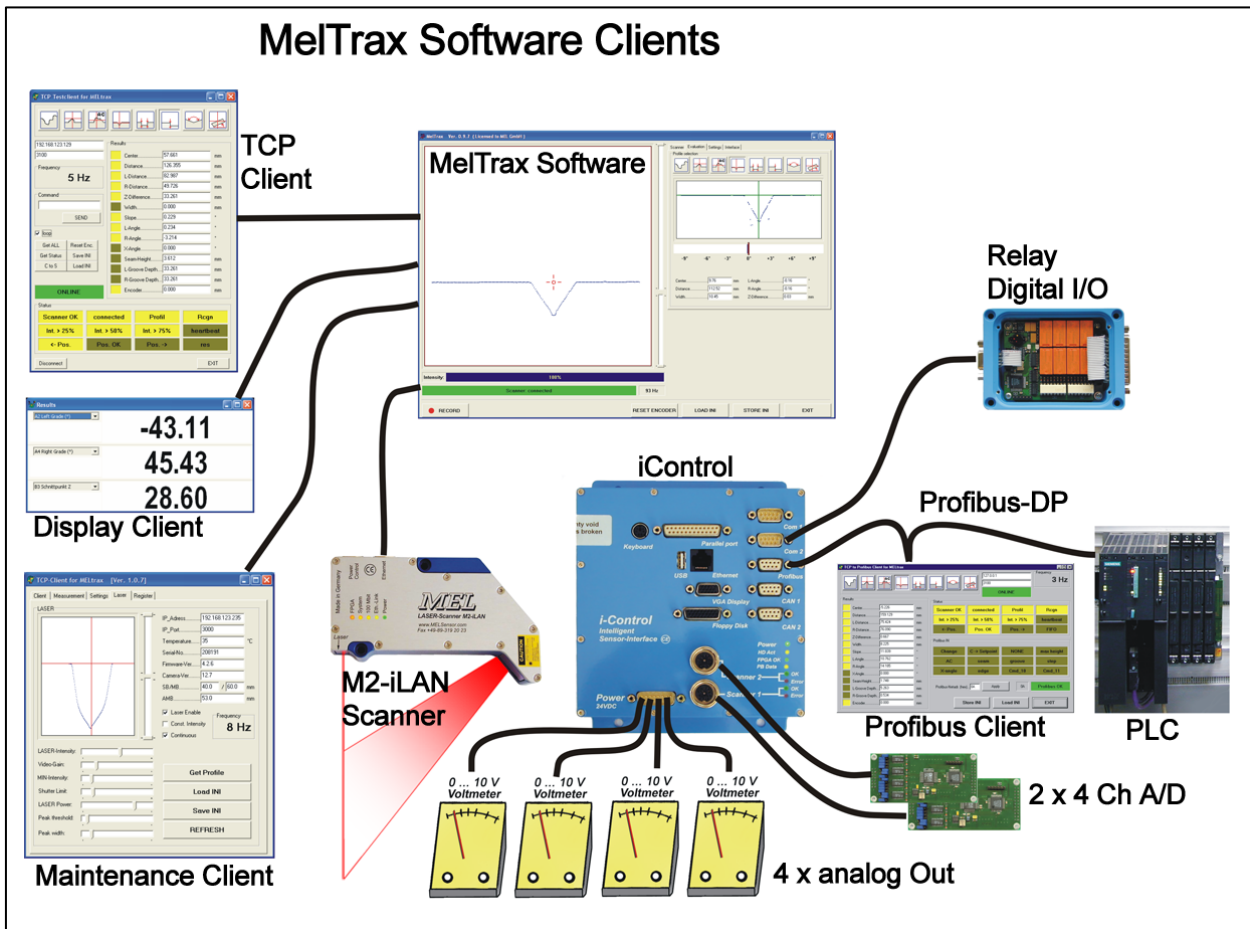

MelTrax connects to the M2-iLAN Ethernet Scanner over TCP / Ethernet. When two scanners are required, a second instance of MEL can be launched and connected to the second scanner. One MelTrax instance can use one scanner at a time. For MelTrax, it is not important on which PC it is working. Details for the network configuration are given in the manuals *HB-M2-iLAN-UDP-E.pdf* and the manuals for M2-iLAN-Scanner *HB-M2-iLAN-E.pdf* and *HB-EthernetScanner-E.pdf*.

Various *Clients* can be used on different PC *at the same time*. This allows use of the required function at the place where it needs to be. The communication between the *MelTrax Software* and the *Clients* is made with TCP/IP packets through the network.

When the Clients are connected to the MelTrax application, they receive packets on the port 3100. A number of clients can be active without degrading performance. With different Clients, the application can be tailored to the customers needs in a flexible way.

Encoder

MelTrax receives and processes encoder data delivered with the scan profile data. The encoder information is the y- or movement- axis, the scanner profile has x- and z-axis. Encoder inputs are connected to the scanners digital inputs. The scanner electronic system captures the encoder impulses and transfers the encoder value with the scan profile data to the MelTrax software. The Record function allows to record profiles including the encoder information. The recorded profiles can be used with other software packages to view, analyse and measure objects in 3D.

VScanner

The *VScanner* is a software-interface for connection of M2D legacy hardware to MelTrax. It connects a local M2D- or M2DW-Scanner head which is attached with the scanner head cable to the iControl over the Ethernet to MelTrax software. This allows connecting "legacy" M2D-Scanner hardware with iControl to the MelTrax software: the *VScanner* is the "software-bridge" between the *M2-iLAN Scanner technology* and the M2D-Scanners connected to the iControl ISA Bus.

The *VScanner* takes up data from the scanners on the iControl's internal ISA bus and sends it out to the MelTrax software over the iControl's Ethernet network. MelTrax software expects data from an Ethernet-Scanner over the network.

MelTrax software could work on the same iControl or on another PC, this makes no difference. MelTrax connects to the IP Address of the sending iControl at port 3000.

The VScanner also serves as File player for recorded files. The check boxes "Enable Server" and "Minimize at Start" should be activated. While the clients of MelTrax software are negotiating connection for a short while the Status bar will show yellow "Waiting for Connect". When the connection is established, the status bar turns green and the number of connected clients is displayed.

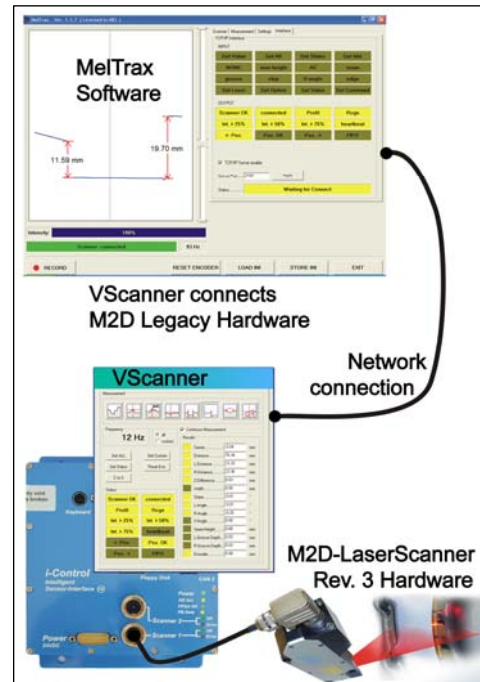

TCP-Client

The TCP Client is for monitoring results and controlling the MelTrax software over the network. The TCP Client shows measurement status and results, connection status and measurement status. You need no monitor, keyboard and mouse at the machine, but the Ethernet network to be installed and enabled.

The TCP-Client client displays the scan profile, the parameters for set up of the Laser Scanner, Scanner status, measurement status, connection status and registering information. To receive a continuous profile display, click the check box Continuous on the Laser Tab. Laser Enable must be checked to enable the Laser; this allows also switching off the Laser for security during maintenance or cleaning.

The TCP client also allows *remote unlocking and registering* of the MelTrax software. For details see the chapter "Register and unlock" on page 42.

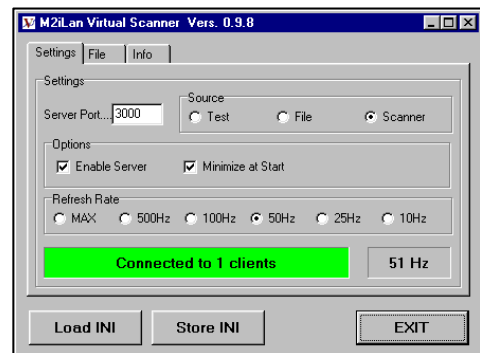

Profibus-Client

The Profibus Client requires the Mel M2-iControl hardware for access to the Profibus. MelTrax software has no direct Profibus interface. MelTrax can be active on any PC in the network; the Profibus client on the iControl will receive data from MelTrax and output it onto the Profibus, as well as it receives data and commands (see Profibus interface description on page 21) from the Profibus master and sends data and commands to the MelTrax software.

CANbus-Client (planned)

The CANbus Client requires the Mel M2-iControl hardware for access to the CANbus. MelTrax has no direct CANbus interface. MelTrax can be active on any PC in the network; the CANbus client on the iControl will receive data from MelTrax and output it on the CANbus, as well as it receives data and commands from the CANbus and sends data and commands to the MelTrax software.

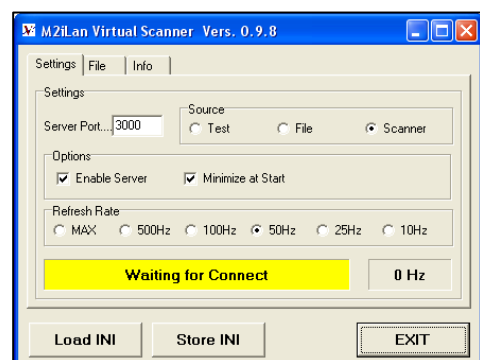

MelTrax Software Manual

Display-Client

The Display Client shows selected results as big number displays on the monitor. This makes adjustments and tracking threshold limits easier. Additionally, the new Display Client can show history graphs of selected parameters from recorded files. This allows to research dynamic behaviour of machine positioning. The history graph display can be zoomed to show small details.

Analog Client

The Analog Client *requires* the MEL iControl hardware to output up to 4 selected results as 0 ... 10 V output signals at the D-Sub-15 pin power connector of the iControl. Analog Client and a lean Display Client have now been combined in one single *combined* Client. The Analog Client can display 4 selected parameters as numbers on the screen and in the same time output these signals as analog Voltage of 0...10V on the power connector D-Sub-15 on the iControl. The Analog client requires the Giveio.sys driver to be installed and activated on the system. Details on **page 48**.

Selection Client

The selection Client is made for quick switching between pre set program configuration sets. It may also be used to switch from German to English language. All parameters and settings defined by the configuration set numbers are switched over with the push of a "button".

Relay/Digital I/O-Client

The Relay Client requires a Com port at the PC. i-CR-8 relay and digital I/O box is connected to the RS-232 Com port and receives the I/O signals over the RS-232 interface. The Relay client provides up to 8 relay output contact (closing contact) and up to 8 digital inputs (optic isolated)

Example for a Relay Client

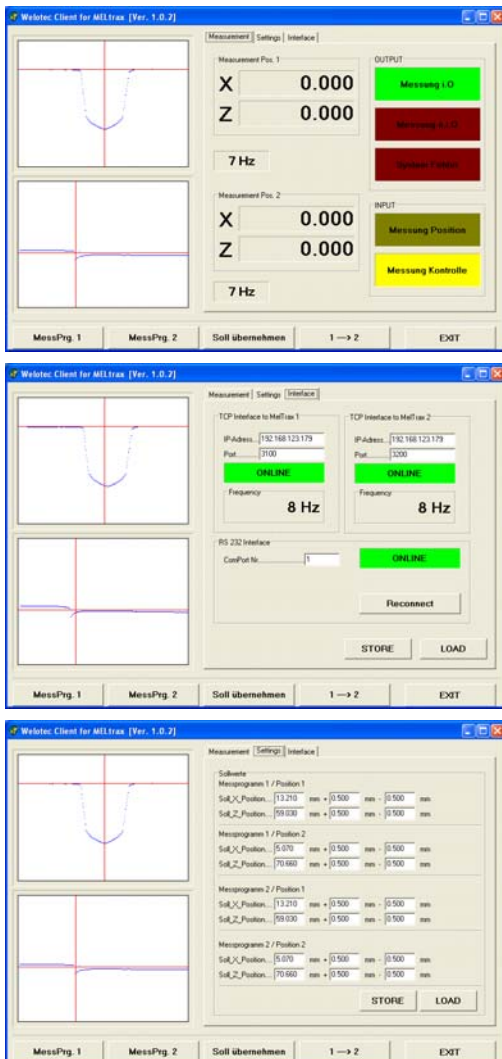

Cable for Relay box iCR-8 (example)

Length: 2,5m

-- open ends with crimp sleeves (for terminal block)

Required = 11 wires

DSub25 female

Digital inputs

=====color====Pin (Dsub25)=====

- 1= Enable black 8
- 2= Measurement 1 red 21
- 3= Measurement 2 yellow 9
- 4= take over blue 22
- 5...
- *

Relay outputs

=====color====Pin (Dsub25)=====

- 1= ready brown 2
- 2= Measurement ok purple 15
- 3= Measurement nok grey 3
- 4= result rose 16
- ...reserved grey+rose 18
- 8= error blue+red 7
- *

power

- GND green 14
- + 24 V white 1

Two bridges in the D-Sub-connector:

- a) 1 - 4 - 5
- b) 14 - 10 - 25

Signal Output Options

1. software TCP Client Ethernet TCP connection to control PC
2. software S7 Client Ethernet TCP connection to S7 PLC
3. iControl * Profibus Client
4. iControl Analog Client 4 analogue outputs 0 ... 10V
5. iControl Analog Client Digital output signals left / right / OK
6. Serial Relay box Relay Client Digital output signals left / right / OK

Signal output is made in parallel over digital outputs and Profibus (iControl)

* PCI Profibus card (only in combination with industrial PC) on request!



A detailed description of the various clients and their applications is given in the second part of this manual after the introduction to the MelTrax Software.

The main screen User Interface

The left side of the GUI always shows the profile. The right side of the GUI is divided in 6 tabs: Scanner, Measurement, Settings, Interface, Buffer and Register. The tabs select the functions for set up, zoom display and display of interface information.

Screen tab	Function
Scanner	Scanner adjustments: Scanner IP address, Laser intensity, operating mode, Video gain
Measurement	Select algorithm and display results
Settings	Set up parameters
Interface	Display of relevant interface signals and client connection status
Buffer	History graph
Register	Register & unlock

The 6.th tab, the Register tab disappears after unlocking is complete. Set up of tracking cursor and measurement display are adjusted on the tab "Settings".

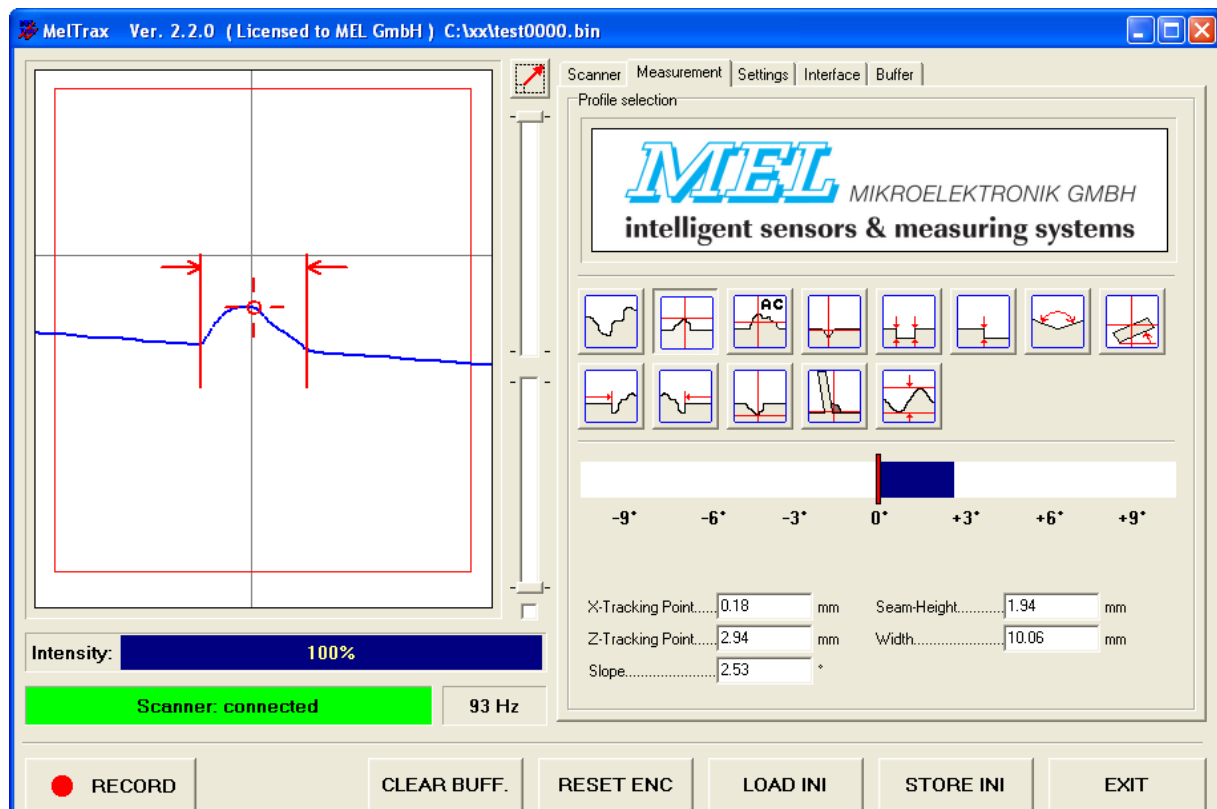

Selection of Algorithm for profile evaluation is made with a mouse click on the Icon, or – as later explained- by remote steering from PLC or TCP Client. MelTrax is using distributed intelligence. Each Client can make selection and parameter setting, independent from where it connects over network.

Measurement: Select Algorithm

Choose the algorithm from the *Measurement tab*. Example: Amplitude; Algorithm No. 12.

Selection of algorithm can be done with mouse or over network with TCP command from any MelTrax client.

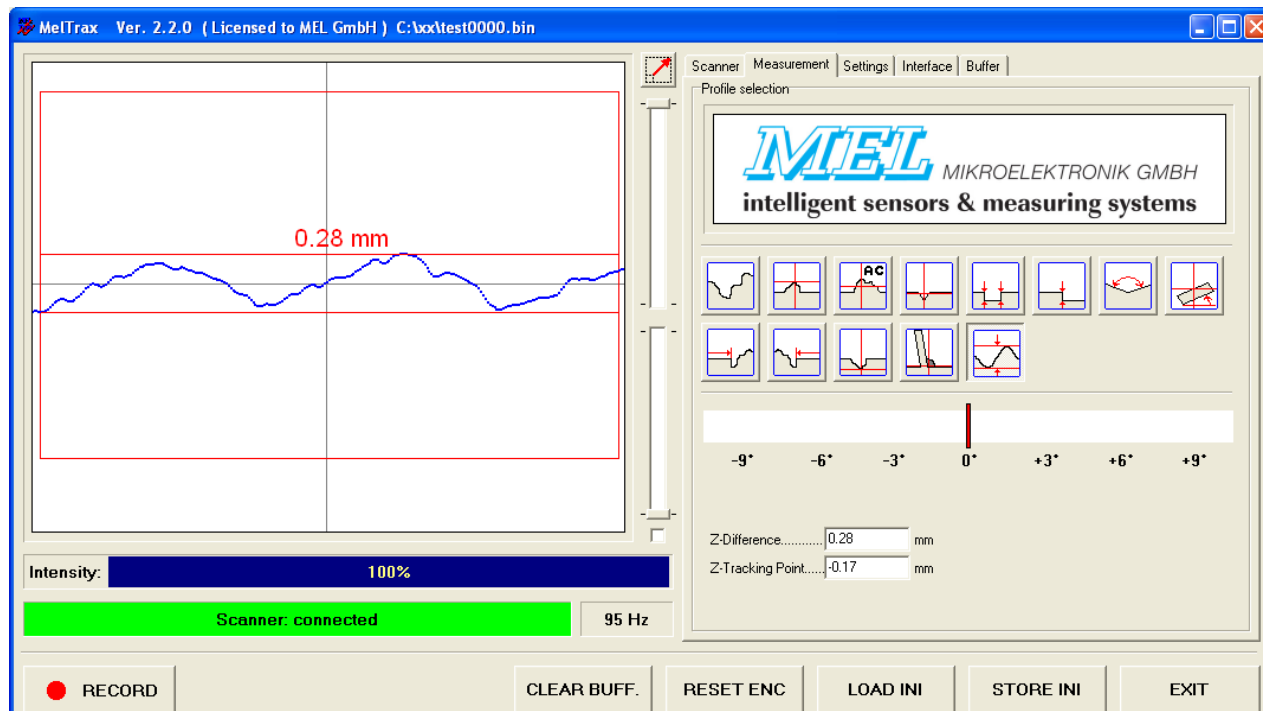

12 Algorithms are available:

Nr.	Function	Remarks / application
0	Profile	Profile display, no evaluation
1	Highest Point	Tracking seam inspection system using ultrasonic test heads; pipeline production
2	Highest Point + Area centroid	Tracking seam inspection system using ultrasonic test heads; pipeline production Tracking follows the center of gravity point of the seam
3	Seam Tracking	Automated welding (for v-shaped groove)
4	Groove measurement	Measure groove width, depth
5	Edge / Step	Measure Step height and edge position
6	Angle	Measure enclosed angle
7	Slope	Measure edge position and slope (positioning for robot welding application)
8	Left edge tracking	Seam tracking; automated welding
9	Right edge tracking	Seam tracking; automated welding
10	Lowest point	Seam tracking; automated welding
11	Fillet weld	Seam tracking; automated welding
12	Amplitude	Measure min / max value in profile
		Additional algorithms may be added without further notice.

Simple GUI

When the Option *Simple GUI* is selected, only the scan profile is displayed. All other elements of the user interface disappear: the right part of the screen is hidden. In this way, the display is smaller than the complete MelTrax screen. This allows viewing the profile on a remote screen without wasting too much space on the screen.

SHIFT + T toggles the view to see full screen view.

SHIFT + S saves window position and size

Simple GUI can be set up only in the Xconfig.ini file. It can not be disabled or enabled with mouse or keyboard on the user interface. (See **page 58** for details on the Xconfig.ini file). This may also be used as an option to make the display safe against thumb user's manipulations.

Technical support, algorithms and mathematical methods

Algorithms are developed and integrated into the MelTrax software bundle on a continuous basis. Depending on customer request and scheduled project development, updates and new releases will be published on a non regular schedule. For more information please contact MEL.

For problems with installation, registration, requesting unlocking key and for advise of solving special recognition problems please contact MEL technical support: e-mail to mail@melsensor.de

In urgent case use MSN chat or Skype to contact technical support or call +49-89-327 150 - 0

Support hotline is available on normal working days in Germany from 8 a.m. to 5 p.m. Central European time.

MelTrax Software Manual



Select measurement algorithm

On the measurement screen the algorithm is selected according to the object geometry. When the Icon button is clicked, the button is shown like pushed in and the algorithm becomes active. Depending on the algorithm, the measurement result displays are shown. In the following text, the various algorithms are explained.

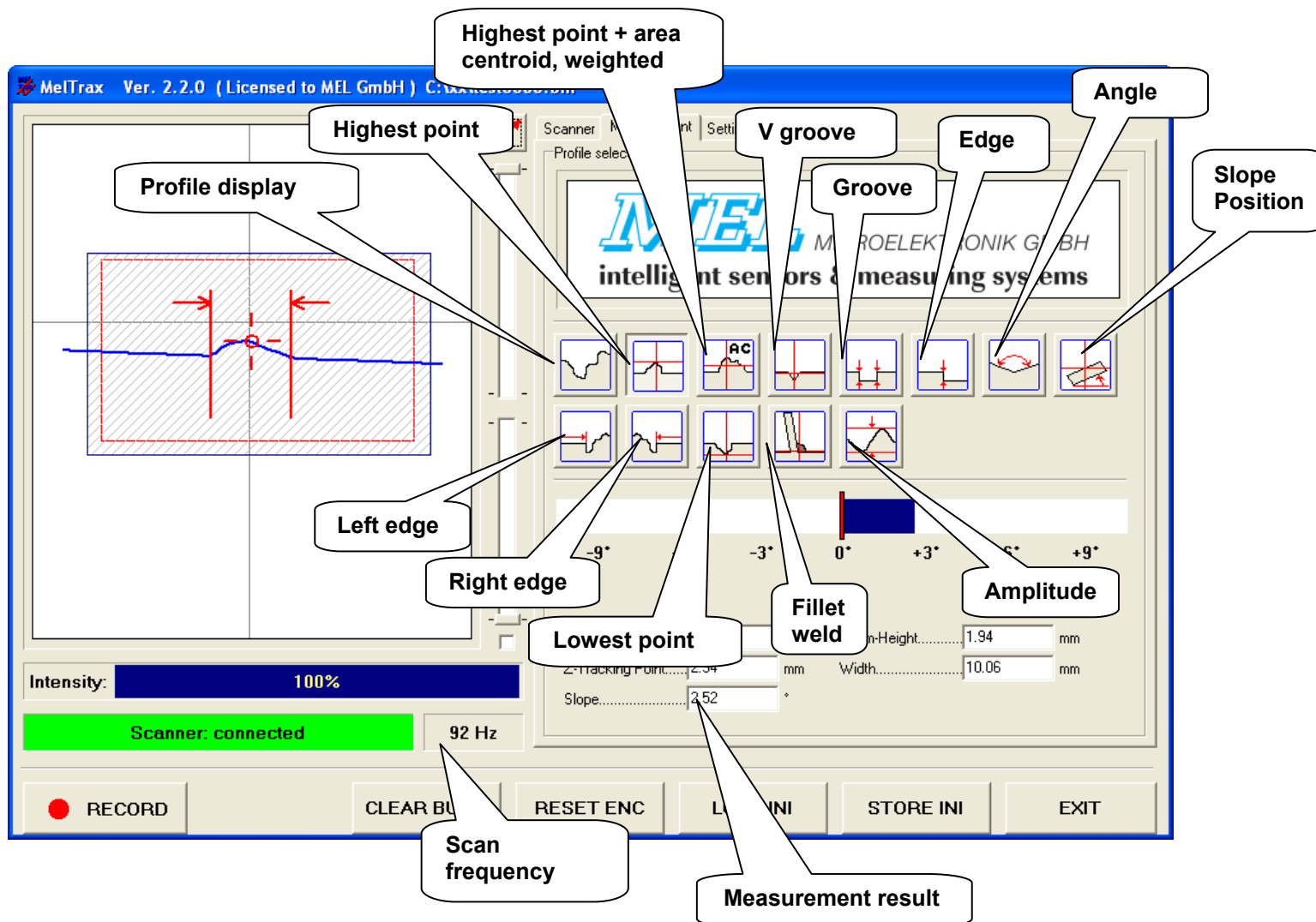

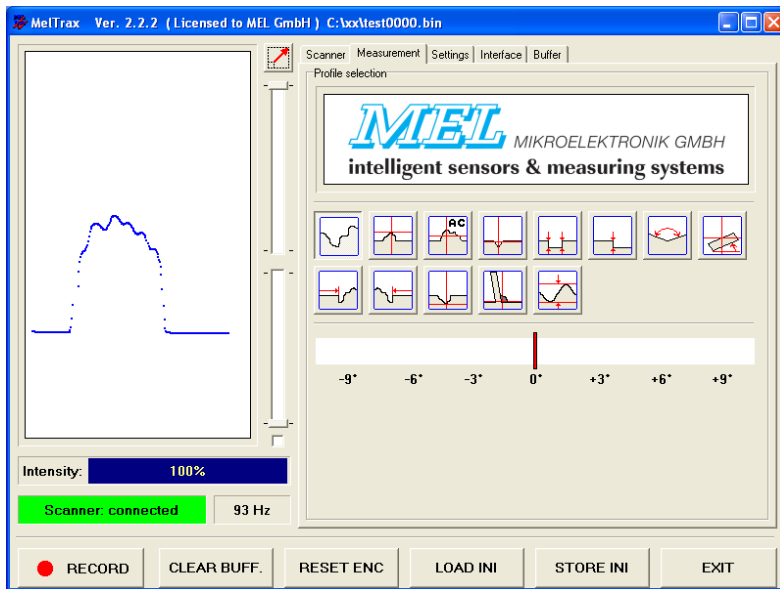

0 Profile display

Algorithm No. 0: profile display mode
- no mathematical evaluation is made.

The MelTrax display can be rescaled by dragging the window borders horizontally, vertically or diagonal at the borders / edges.

On the Scanner Tab the thickness of the profile representation can be chosen: thin, middle and thick.

Display mode No. 0 has no parameters, no cursor display and no adjustments.

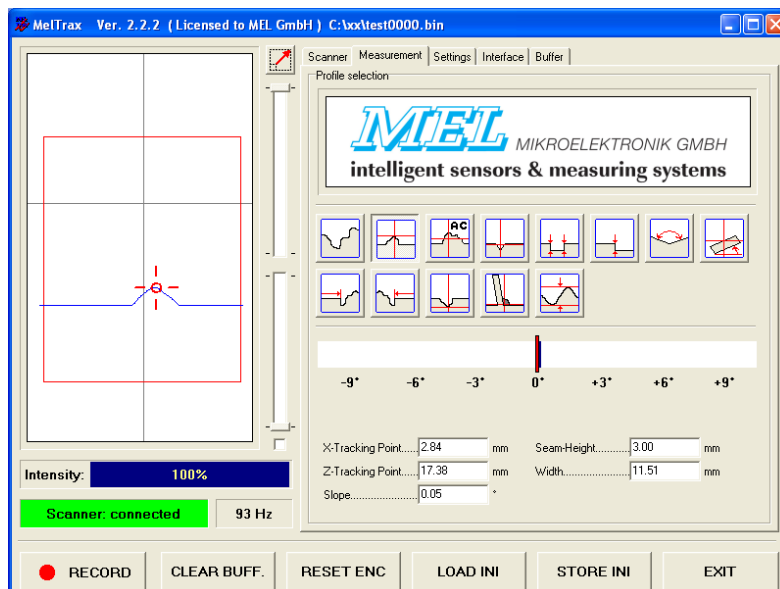

1 Profile – highest point

The algorithm No.1 „highest point“ looks for the maximum peak in the profile. The profile is filtered (smoothing) *before* maximum peak search is done. The average tilt angle is measured continuously and considered by the algorithm when making the mathematical evaluation. The angle is shown on the screen as blue bar below the program icons.

This algorithm is used for tracking of the welded seam for example in ultrasonic testing of water and gas pipelines.

The minimum height of the welded seam is defined with the parameter „Min Height“ in the settings page. This parameter should not be set to zero, to avoid noisy behaviour of the algorithm, but it could be set to a very small value like 0.05 mm.

Width is measured and displayed when the display is activated with the settings checkbox “Show Width” is activated. The measured width depends on the “Rcgn-Heigth/Depth” setting.

Parameters:

- Setpoint
- Min Height
- Hysteresis
- Search Depth
- Search Approx

Setpoint

The Set point is the zero point of x and z axis. For analog outputs, the setpoint is +5V. For result display as X-Tracking point and Z-Tracking point the output value is 0.

Center on edge

For asymmetrical profiles of the type highest point the option “Center on edge” should be enabled.

The option “Center on Edge” takes the outer borders (edges) and calculates from there the tracking point x-coordinate.

The same applies to the algorithm “min height” (a.k.a. deepest point). This algorithm can be used for the same profiles when the option Z-Mirror is activated.

MelTrax Software Manual

2 Profile – highest point + Area Centroid (weighted)

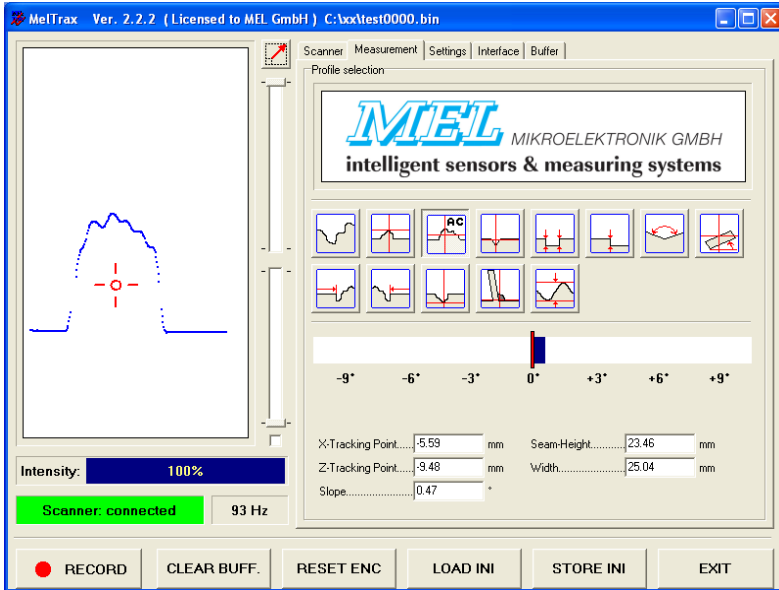

Algorithm No. 2 “highest point + Area Centroid” (AC) is looking for the highest point and also calculates and considers the *center of gravity*.

Both parameters are weighted and give the measurement result. The tracking cursor Z (height) is placed on the area centroid height. The tracking point is deeper than the maximum peak and appears inside of the object.

Algorithm 2 is used like No.1 for tracking of the welded seam.

Like in No.1, the tilt angle is considered in the calculated result and displayed as a blue bar on screen.

Parameters:

- Setpoint
- Hysteresis
- Search Approx
- Min Height
- Search Depth

3 Seam Tracking

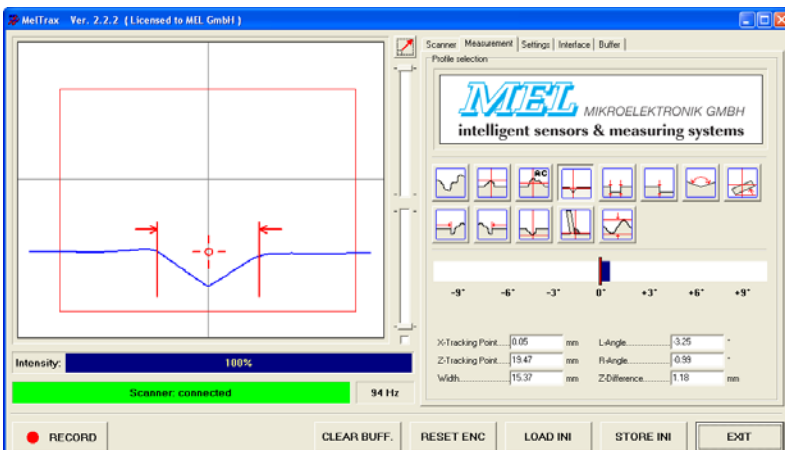

Algorithm No.3 „Seam Tracking“ looks for edges in the profile and calculates the tracking point in-formation for the welding machines torch support motor.

The algorithm may be used also for welding or other machining processes as grinding or soldering.

The algorithm looks for the left and right edges. From the position of the edges, the tracking information is calculated.

Parameters:

- Setpoint
- Filter Depth
- Min Side Length
- Noise Reduction
- P-Plausibility
- Left Gap Level
- Search Depth
- Left Angle
- S-Filter
- S-Plausibility
- Right Gap Level
- Search Approx
- Right Angle
- Smooth
- DSS
- Max Slope
- Slope Setpoint
- Force to V Shape

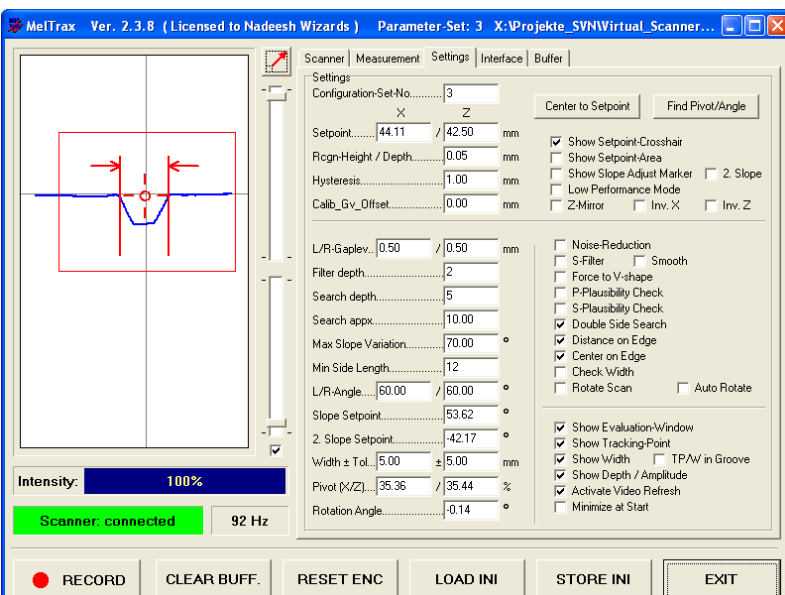

For seam tracking relevant are „L/R-Gaplev“ = Left and Right Gap-Level. These are the points below the surface, where the x and z coordinates of left and right groove sides are tracked.

Setpoint defines the coordinate of the zero point relative to the scanner coordinate system. Output of tracking point signals is relative to the setpoint.

For adjustment under working conditions, the scanner must be mounted mechanically over the seam, so that it can see the prepared seam in the center of the viewing range.

The settings page is brought up. The parameters L/R-Gap level and some filter settings could be adjusted. The best value for L/R Gap level depends from the roughness and shininess of the groove. The setting should be tested in a dry run.

4 Groove depth | Groove width | Position

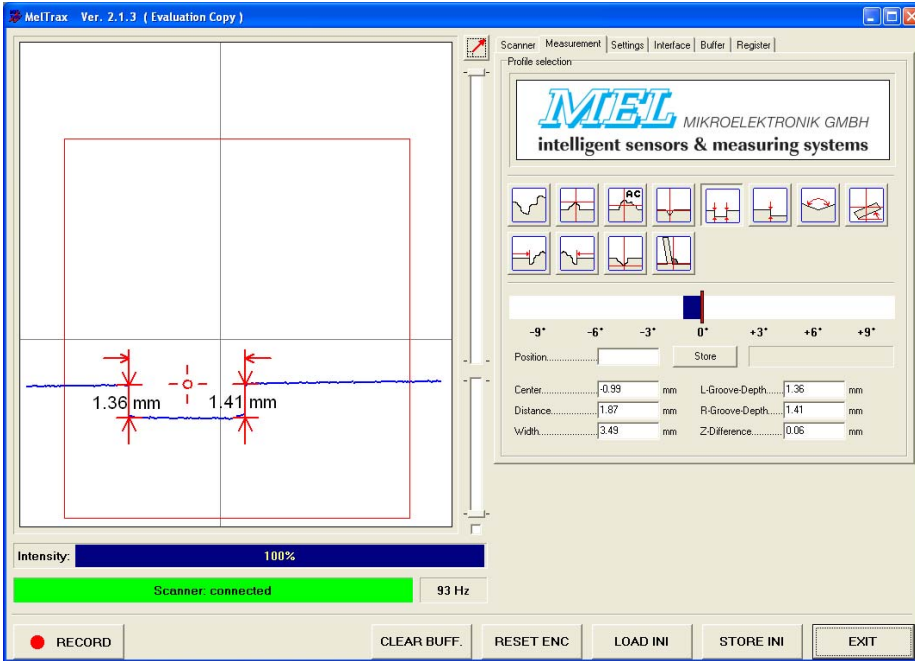

Algorithm No.4 „groove depth / width“ looks for edges, surface and bottom line in the profile and calculates :

- Width
- Left height
- Right height
- Height difference
- Average Position x and z

The cursor (tracking point) is placed in the centre of the groove.

Please note that the screen cursor display can be switched on / off by selecting the settings options without any influence to the measurement.

The measurement results will always be sent out, when the algorithm is active and the Recognition signal is active.

Parameters:

- | | | | |
|------------------|-----------------|----------------|---------------|
| Setpoint | Calib_GV_Offset | Left Gap Level | |
| Right Gap Level | Filter Depth | Search Depth | Search Approx |
| Max Slope | Min Side Length | Left Angle | Right Angle |
| Slope Setpoint | Noise Reduction | S-Filter | Smooth |
| Force to V Shape | P-Plausibility | S-Plausibility | DSS |

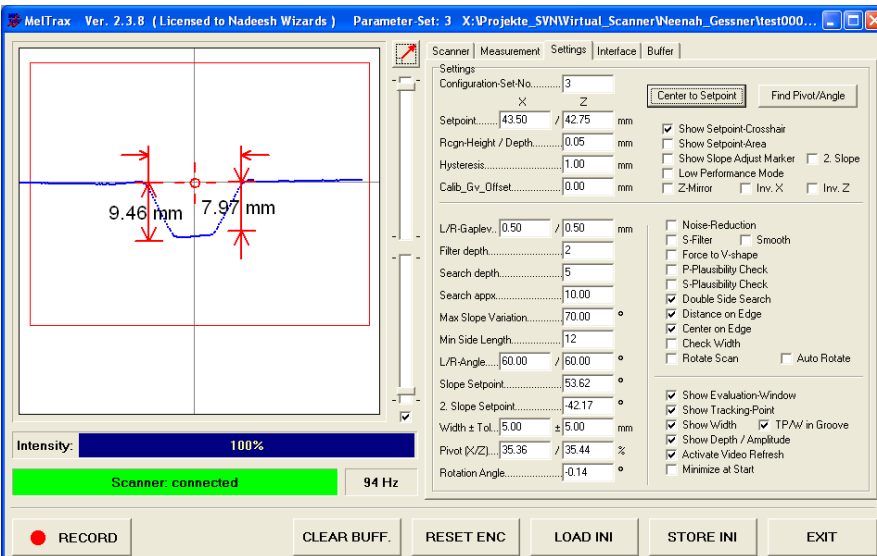

In our example the height of the deformed groove is shown with the parameter “TP/W in Groove”.

The tracking point is calculated with the setting “Center on Edge” as average of the position of both edges.

The edges are defined with the setting of “L/R-Gaplev” (Gap level; recognition point)

the edge point is the point on the scan profile, below the surface, where the z-value differs by the value of the given Gap level.

5 Edge | Step height | Position

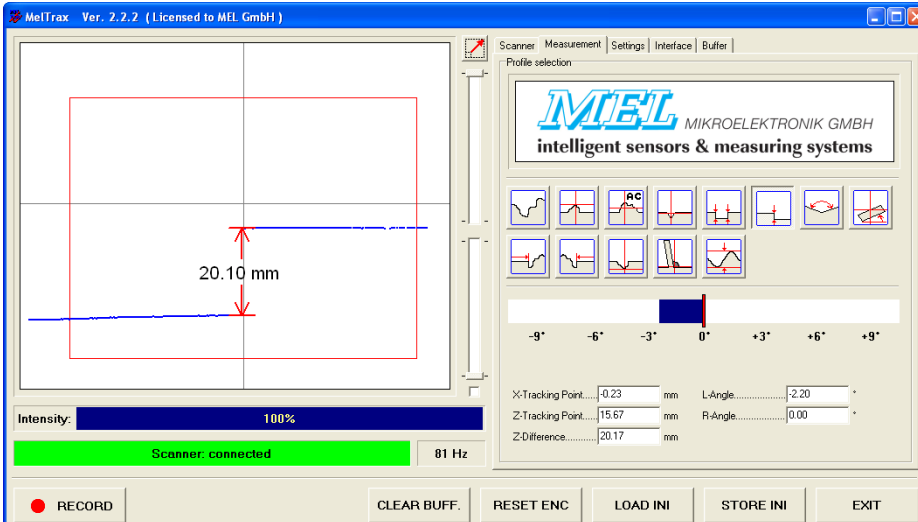

Algorithm No.5 „Step height / Edge“ is looking for edges, surface and bottom line in the profile. The algorithm calculates one edge / step in the evaluation window.

The tracking cursor x-position is at the edge, the z-position of the cursor is in the middle of the step.

When show tracking point is selected, the red cursor display may overlap with the dimension display of step height.

Parameters:

- | | | | |
|------------------|-----------------|----------------|---------------|
| Setpoint | Calib_GV_Offset | Left Gap Level | |
| Right Gap Level | Filter Depth | Search Depth | Search Approx |
| Max Slope | Min Side Length | Left Angle | Right Angle |
| Slope Setpoint | Noise Reduction | S-Filter | Smooth |
| Force to V Shape | P-Plausibility | S-Plausibility | DSS |

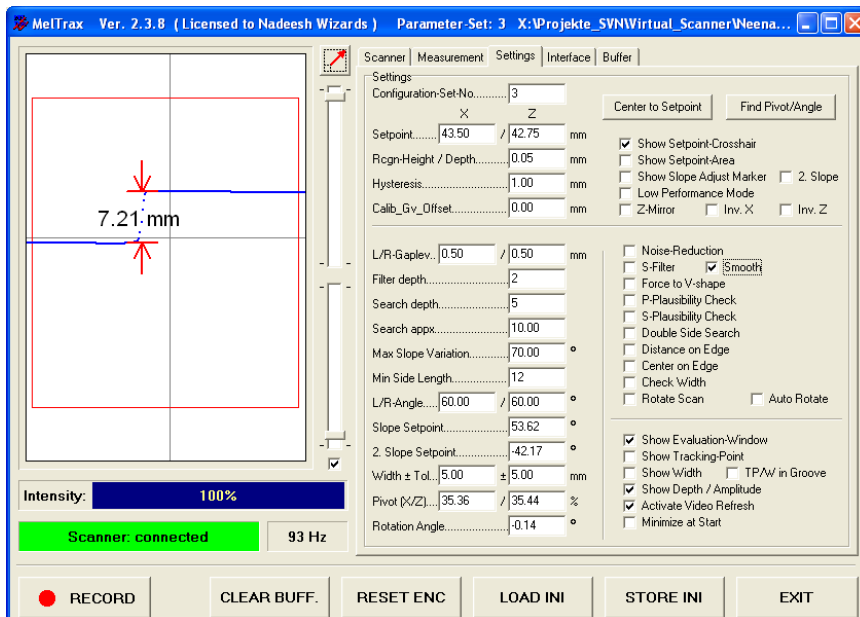

For edge recognition it is recommended to switch off all cursor display options, except “Show Depth”.

The tracking cursor (the cross hatch) would be placed exactly on the step and overlay the display of the step height measurement value.

To make the position of the step contour more visible, we have switched on “smooth”.

The Step contour is rounded by the smooth filter, but this has no impact on the algorithms calculation result. Under normal condition it is not mandatory to switch on “Smooth”, it is just an “option”.

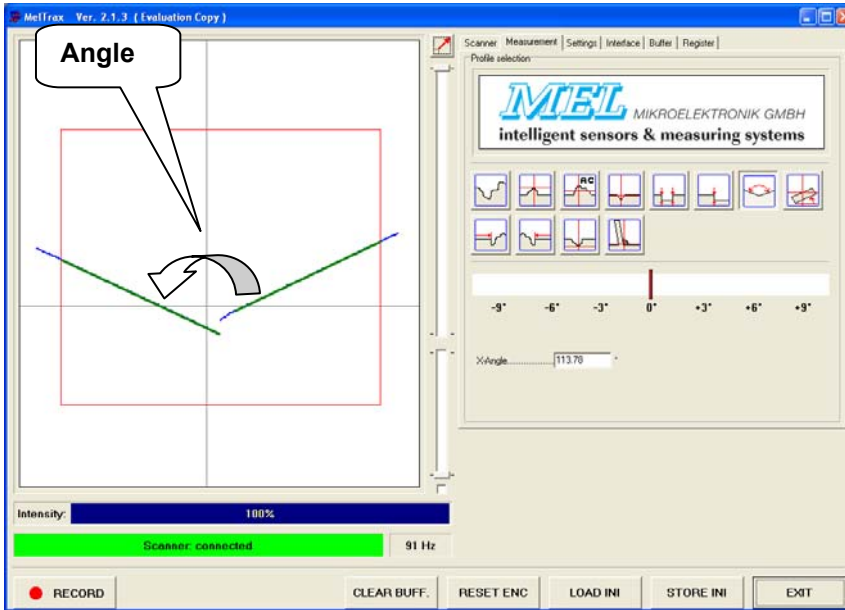

The X-angle algorithm looks for the *longest* straight segments in the profile. The recognised straight segments are marked in green colour, segments refused by the algorithm are marked in red colour.

The measured angle is the enclosed angle on top of the profile. The angle can go from nearly 0° to nearly 360° in angle.

The object should be more or less flat. On curved surfaces, the x-angle algorithm will make an average of the surface angles. This may cause unstable and incorrect readings. The algorithm takes the longest straight in the profile on both sides.

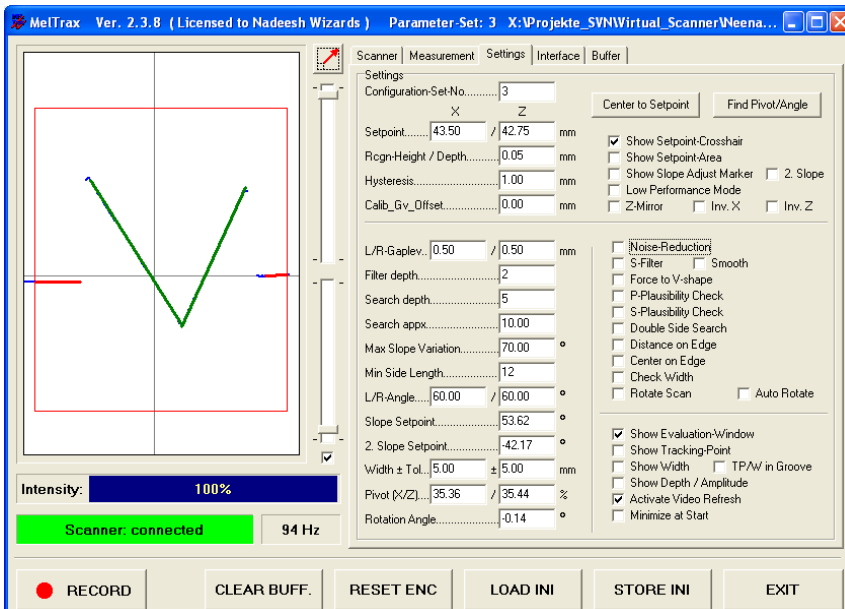

☞ inside very narrow gaps and extremely steep angles, the scanner would not see enough profile points to deliver a stable measurement.

The angle algorithm should be used to measure *almost straight surface* elements.

Examples:

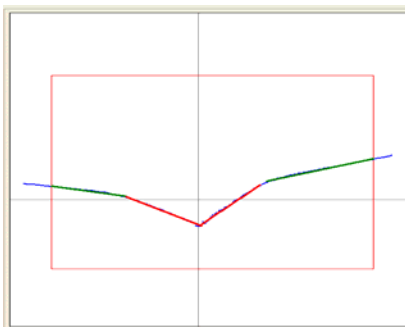
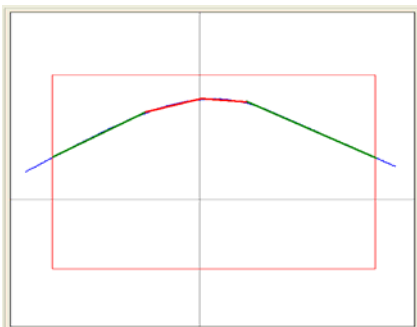

Parameters:

Setpoint Hysteresis
Search Depth Search Approx

☞ Calculation of angles always refers to the green marked segments. Red marked segments or not marked segments are excluded from calculation of angle.

7 Position + slope

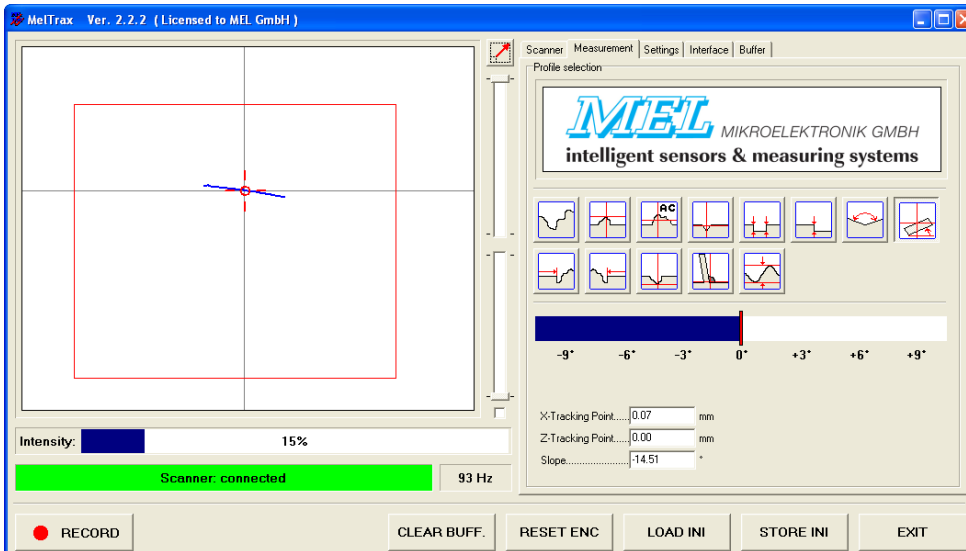

The algorithm No.7 „Slope“ detects and measures the sheet edge position and the angle of the sheet edge.

This algorithm has been created for the assistance in robot welding applications for finding sheet metal edges of several mm thicknesses.

Displayed results:

- x-Tracking point
- z-Tracking point
- slope

Parameters:

Setpoint Hysteresis
 Search Depth Search Approx

8 / 9 Left Edge and Right Edge seam tracking

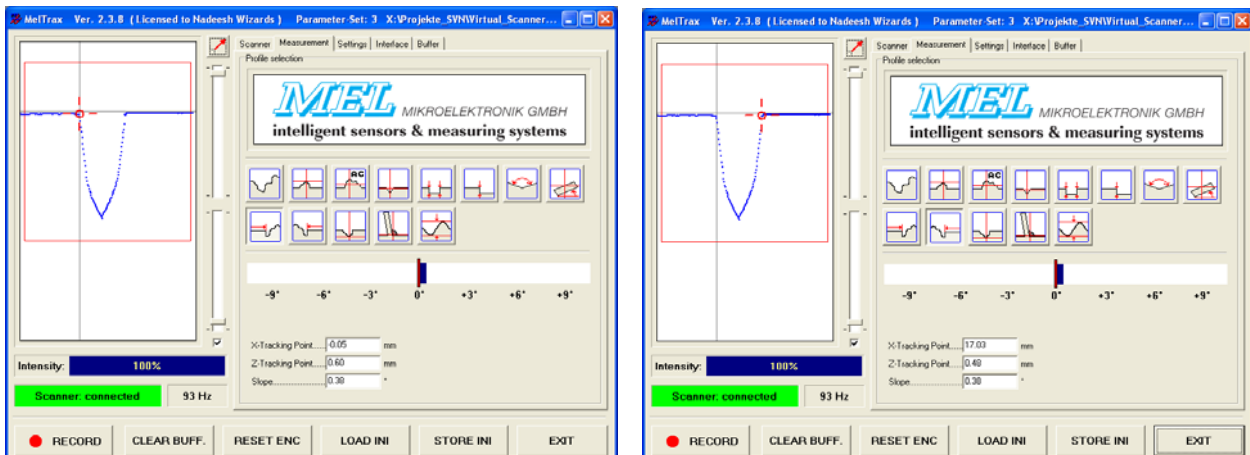

Algorithms No.8 and No.9 for *Left and right edge seam tracking* detects the tracking position *from one single side* or *“single edge”*. These algorithms may be used when the geometry of the groove is shallow on one side, and the other side gives clear tracking information. Please consider: when switching from left side to right side tracking, the tracking point must be re-calibrated with *“Setpoint to Center”* command!

☞ When none of algorithms No.8 and No.9 will deliver stable result, the following algorithm No.10 „deepest point“ might help to find a stable seam tracking!
Algorithms No. 8, 9 and 10 are used in seam tracking / welding applications. Algorithm No.11 is for fillet weld.

Parameters:

Setpoint	Hysteresis	Left Gap Level	Right Gap Level
Filter Depth	Search Approx	Max Slope	Min Side Length
Slope Setpoint	Search Depth	Search Approx	

10 Deepest point (Min Height)

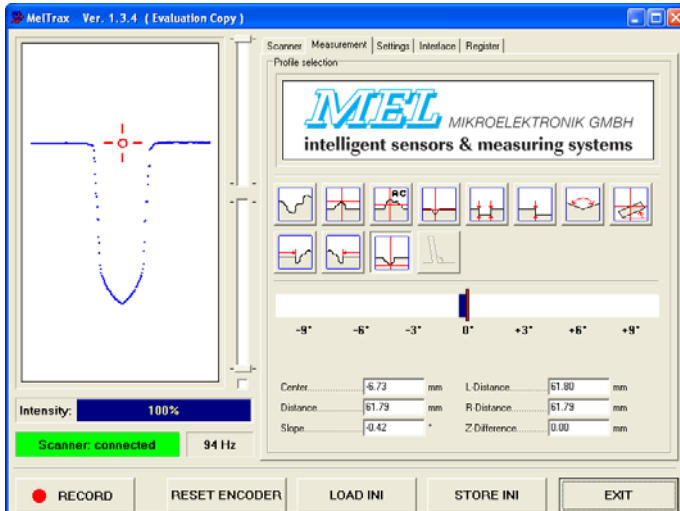

When the edges at both sides of the groove are both shallow, but the *area of deepest point* of the profile is visible good enough, this algorithm can give good tracking stability.

The x coordinate is given from the deepest point information; the z-information is taken from the average of the surface. This will give almost stable tracking results.

☞ when the option „Distance on Edge“ is activated, the tracking cursor height information is taken from the edges and not from the deepest point in the profile. The result is shown in the picture on the left side.

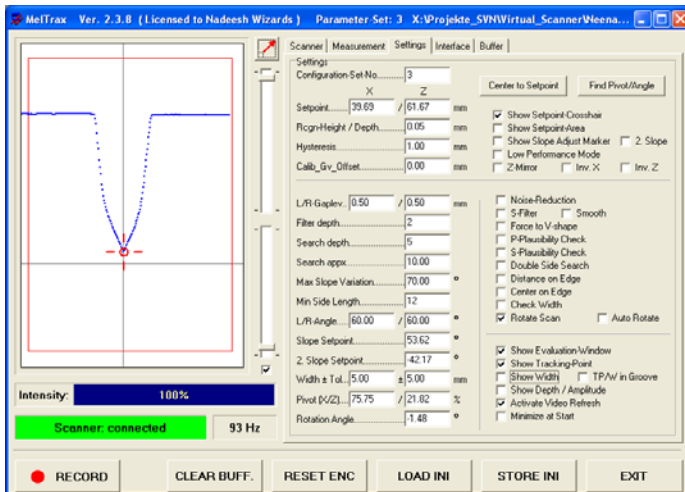

The standard settings without the option „Distance on Edge“ shows the tracking cursor at the bottom of the groove, as shown in the picture on the left side.

Parameters:

- | | |
|-----------------|----------------|
| Setpoint | Hysteresis |
| Filter Depth | Search Depth |
| Search Approx | Max Slope |
| Min side length | Slope Setpoint |

Algorithm No. 10 is good for objects which do not have clear edges, or the shape varies over the circumference, like stainless steel containers for the beverage industry.

☞ Check with your real seam in a dry run which algorithm gives best results.

11 Fillet weld



Two pieces of sheet metal are placed in an angle of approximately 90° in angle. The scanner is adjusted mechanically so, that it is approximately in the half of angle. This way, the scanner sees two straights of 45° angle in the profile window.

☞ the display of the profile window is *not proportional*, therefore the angles in the profile window are not reported true. When you resize the profile window with the mouse, you may then see the correct angles in the profile window. The distorted display has no impact on the calculation of angles!

The calculation is always done from the raw data considering the scanners geometry data.

All data is given in the scanner coordinate system, relative to the Setpoint coordinates.

For an automated motorized control of torch position, the outputs must be transformed to the coordinate system of the master system.

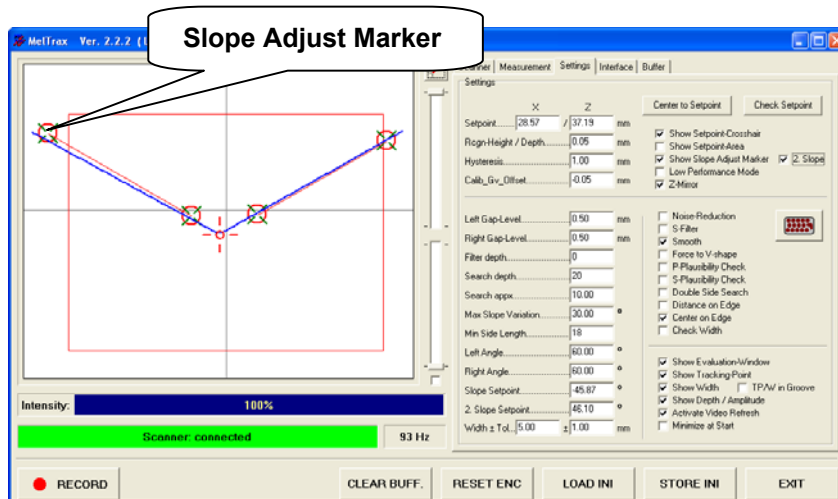

The fillet weld algorithm calculates the cross section point of the profile derived from the two plates.

Coordinates of measurement results are given in x and z of scanner coordinates system. For translation into motor control signals, a coordinate transformation needs to be done first.

The Slope Adjust Markers may be used to set the angle of the groove slopes. The first marker sets the left side slope, the second marker the right side slope. The angle tolerance is set with "Max. Slope Variation".

☞ When selecting the slope adjust markers, place the mouse exactly over the markers cross hatch points and wait until the mouse cursor changes to a cross arrow. Then the marker can be moved to match the profile (as shown in above screen shot). When you do not hit the markers drag point, you may then zoom in *unwanted* your window. The reset zoom button helps to restore the window quickly (see next page).

☞ Parameters Left angle and Right angle are not active with the fillet weld algorithm.

Parameters:

Setpoint	Hysteresis	Left Angle	Right Angle
Filter Depth	Search Depth	Search Approx	Max Slope
Min Side Length	Slope Setpoint		

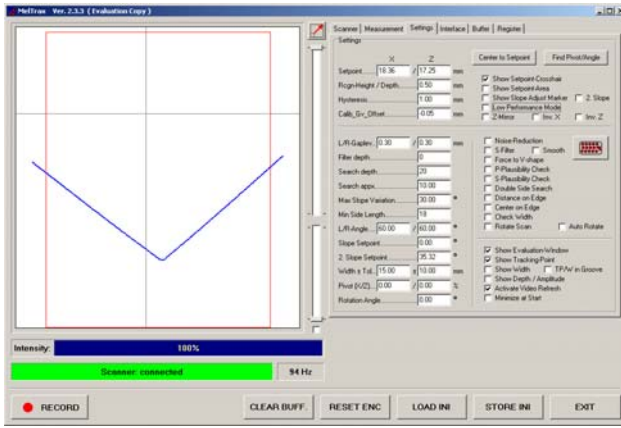

1. the profile is visible
Show tracking point is activated, but no tracking cursor appears...

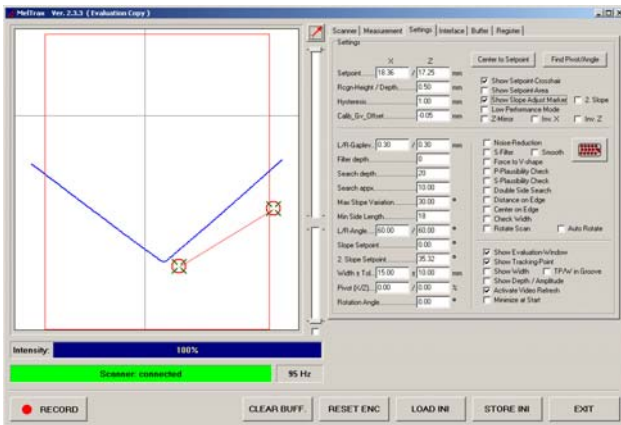

2. activate *Slope Adjust Markers* - with *Slope adjust markers* the angles of the sheets are set.

To adjust the slope place the mouse over the cross marker and wait until the cursor changes into a cross hatch cursor!
Now the slope adjust marker can be moved to match the profile.

When the cursor appears, the angle set up is complete.

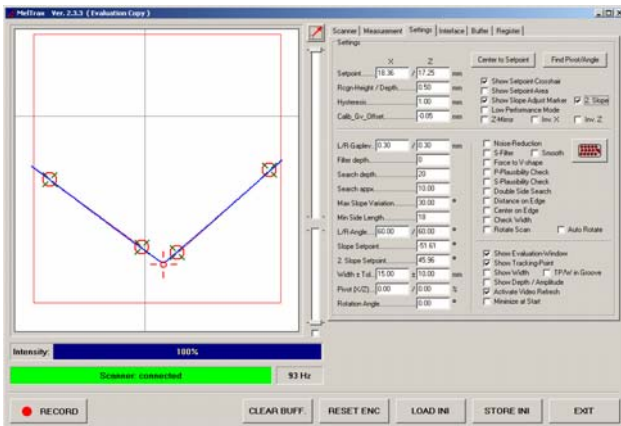

3. Then click „Center to Setpoint“ .

The coordinates of the tracking cursor are saved as „zero“ point.

4. Now set the angle tolerance. The maximum value for the angle tolerance can be defined in the Xconfig.ini file; it should not exceed 45°.

The name of the parameter is „Max Slope Variation“

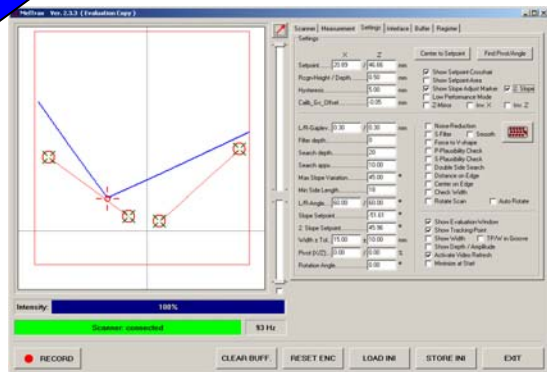
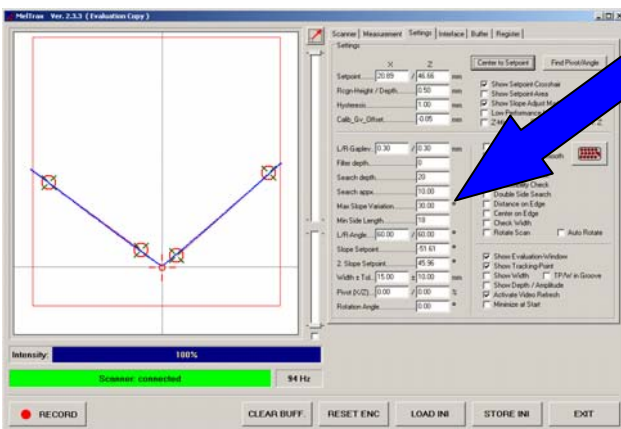

Now the profile can move and the recognition will *not* fail.

5. when a root weld is already there:

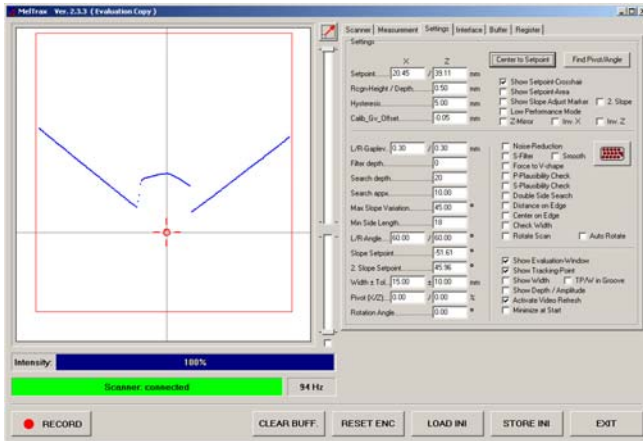

MelTrax Software always outputs the position of the intersection point of the two side flats. when a root weld is already there, the cross-section point is inside the root weld.



MelTrax gives always the position of the cross-section of the two plates,...the root weld is „ignored“.

The offset to the seam top may be constant, when the seam height is constant. When this is not the case, algorithm No.10 – deepest point, could be a solution.

12 Amplitude

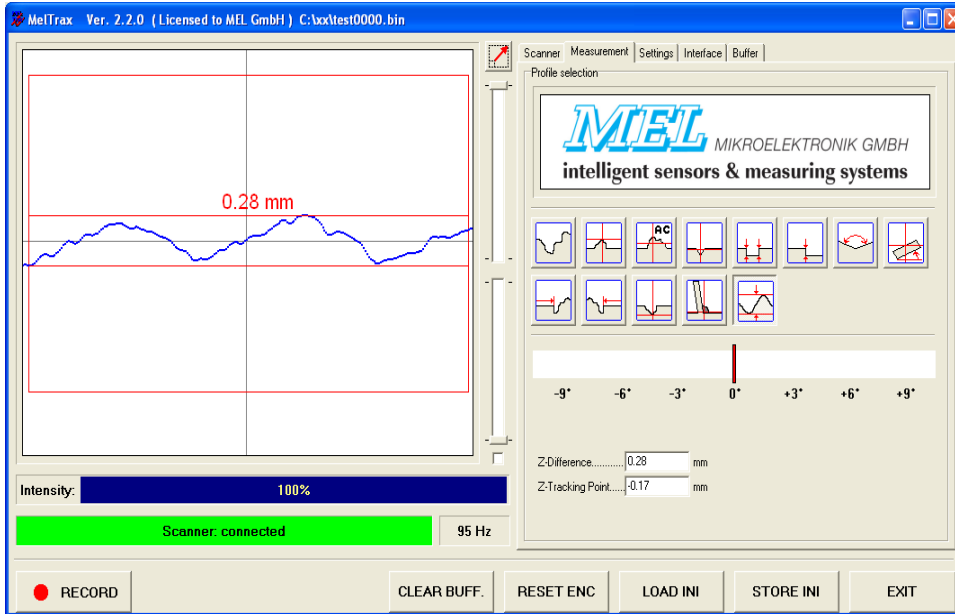

The algorithm „Amplitude“ measures minimum and maximum height of the surface profile and shows the difference of minimum and maximum as „Amplitude“.

The result is displayed and output as *Z-Difference*.

Set the boundaries for the measurement window by *dragging the red rectangle* with the left mouse button.

For rough surface it is recommended to switch on „Smooth“ in Settings. Please note: the checkbox „Show Depth/Amplitude“ must be activated in settings.

Parameters:

Setpoint	Hysteresis	Left Gap Level	Right Gap Level
Filter Depth	Search Depth	Search Approx	Max Slope

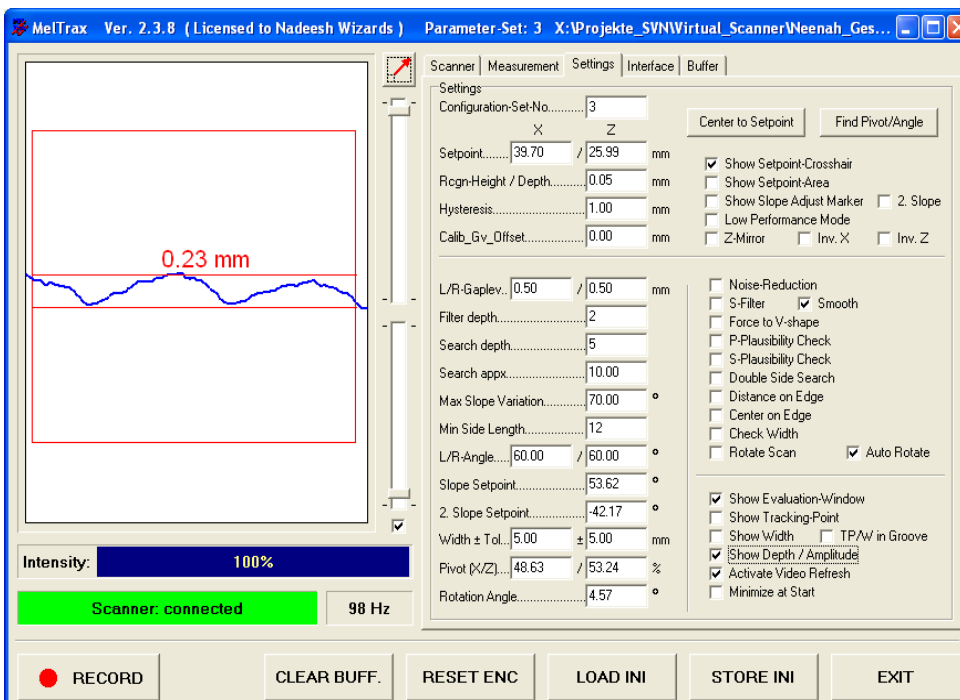

please note: the mouse cursor must be placed a short while over the red line of the evaluation window, until it changes to a double arrow. Now you can drag the evaluation window borders to select the area for active evaluation of the profile.

Impatient people may need to reset the zoom with the zoom reset button.

Resizing the evaluation shall cut out unwanted noise at the edges of the profile.

It is recommended to activate „smooth“ to take out noise.

The option checkbox „Show Depth / Amplitude“ must be activated!

Measurement of „Amplitude“ is supported with the feature „Auto Rotate“. (Details on page 26). This option holds the profile in a flat position, that means the profile is always kept adjusted flat relative to the scanner. This helps to avoid measurement errors.

Zoom

The Zoom function enlarges the rectangle drawn by the mouse.

To set the zoom region, place the mouse to the upper left corner of the desired zoom area, then click and hold the left mouse button. Draw the mouse to lower right corner of the zoom area and release the left mouse button. While dragging the mouse, the selected zoom area is highlighted.

With the right mouse button (click and hold) the whole profile can be shifted, for example to bring the interesting details of the profile to the center of the display.

A click on „reset zoom“ button restores the profile window.

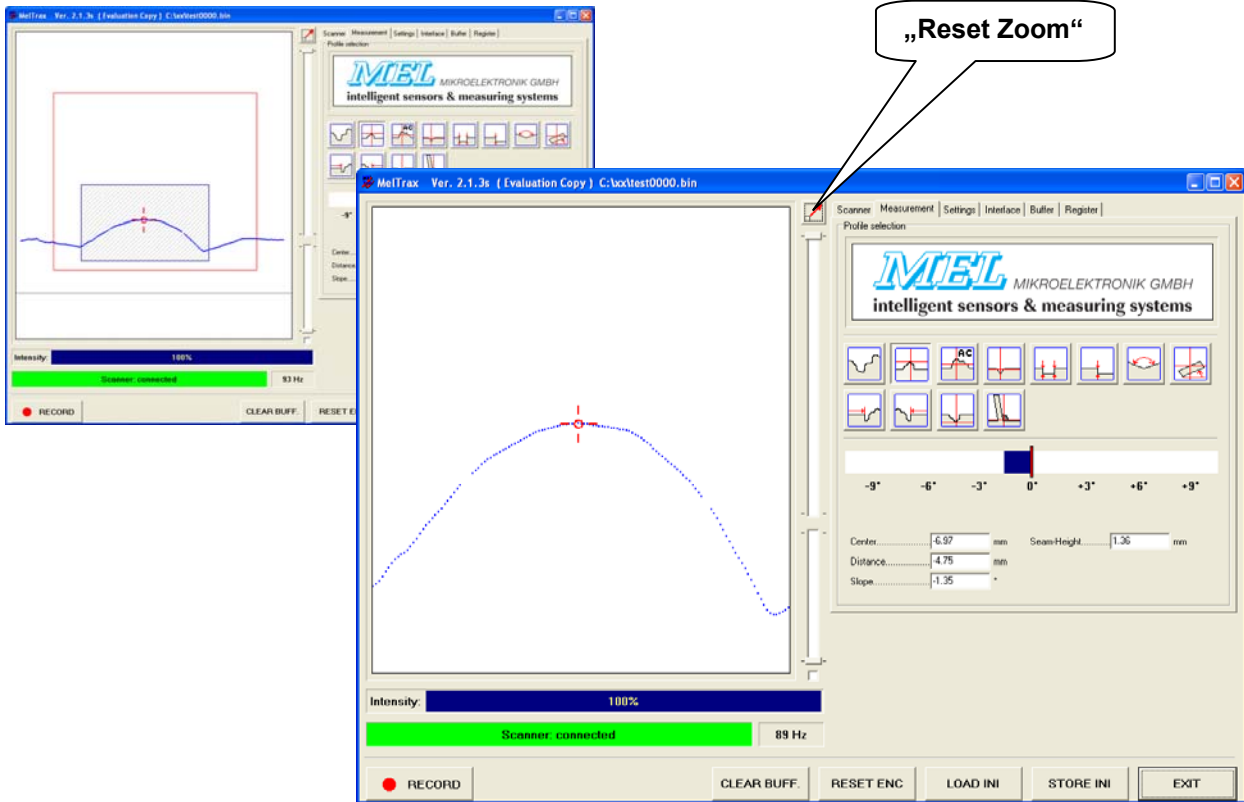

Configuration
Scanner Tab

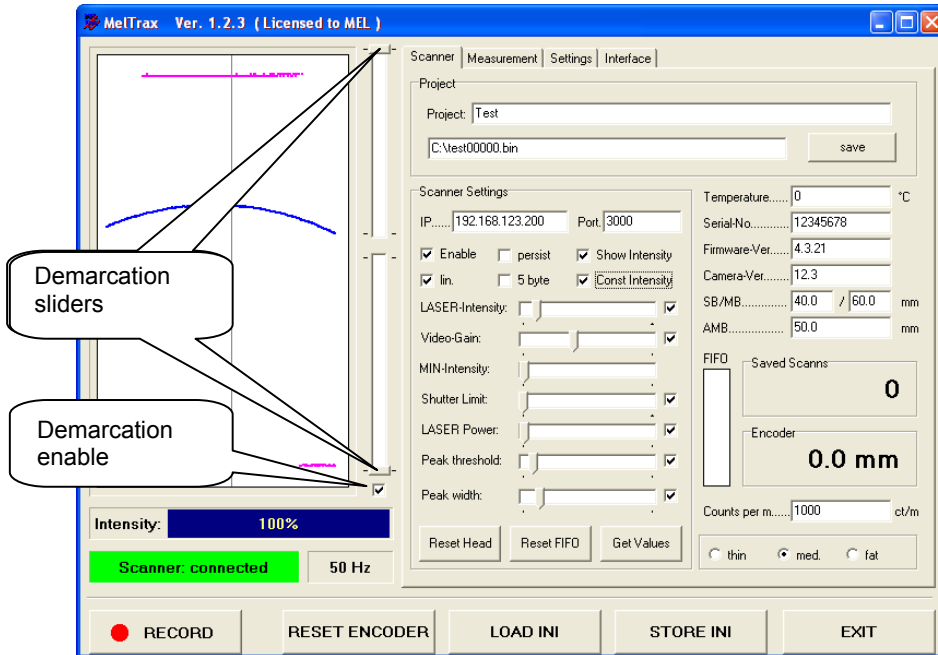

Scanner Parameters

Parameter	Default value	Function	Remarks
Project		Project name	Enter a name you can remember
Path	C:\xx\test0000.bin ***		
IP Address	192.168.123.245	IP Address of the Scanner	Hardware Address
Port	3000	Port	Hardware Port Number
Enable	enabled	switches Scanner on	Must always be on
Lin.	enabled	Switches linearization on	Must always be on
Persist	disabled	Do not erase/update screen	Must always be off
5 Byte	enabled	select 5 Byte Data format	Must always be on
Show Intensity	disabled	Display of pixel intensity	Should be off, except you want to see it
Const. Intensity	disabled *	Laser Intensity	range: 0 ... 1023 (100%)
Laser Intensity	See Screen shot	Intensity slider	Mouse Pop-up shows current value
Video Gain	400 **	Video gain	Do not change!
Min-Intensity	12	Intensity threshold	Do not change!
Peak-Width	15 ... 20	Peak recognition threshold	Do not change!
Demarcation	See Screen shot		Do not change!
Laser niveau	95		Do not change!
Peak threshold	See Screen shot		Do not change!
Peak width	See Screen shot		Do not change!
Temperature		Display only	Temperature of Scanner head
Serial-No	See Screen shot	Display only	Shows serial number of the scanner head
Firmware-Version	See Screen shot	Display only	Shows firmware version of the scanner head
Camera-Version	See Screen shot	Display only	Shows camera hardware version of the scanner head
SB	Depends on model	Scan range X	Width X at the end of range (at max. z).
MB	Depends on model	Scan range Z	Depth of scan window
AMB	Depends on model	Begin of range Z	
FIFO	Fill level of FiFO	Shows fill level of FiFO	When FIFO fills up, the system has a performance problem
Saved Scans	0	Counter of recorded scans	
Encoder	0	Encoder value in mm	
Counts per m	10000	Encoder calibration ref.	Number of encoder counts per meter
Thin med thick	medium	Profile display	medium

* The Intensity slider „LASER-Intensity“ is active, when the Check box „Const. Intensity“ is selected, otherwise the automatic adjustment of shutter time and laser power is active, the slider then has no effect.

** Default value is different for iLAN scanners – see M2-iLAN-E.pdf manual.

*** the path can be set as you like it; example: C:\xx

Demarcation sliders

The demarcation sliders cut the lower / higher portion of the profile. Use the demarcation feature only if you can make sure, that the profile is more or less stationary in a dedicated region of the scan window, and only if necessary. The meaning of these controls is to keep parts of the profile from being recognized by the profile recognition algorithm. This may help in situations, where strong reflections and ambient light are present, but all other conditions are met. Set the checkbox “enable” to on to make the sliders work. Default status is off.

Settings

The settings parameter screen holds the controls for fine tuning of recognition. Best is to use the default settings. The on screen keyboard can be enabled / disabled in the Xconfig.ini file by setting the parameter OSK=1 or OSK=0.



with Windows 7, an error message may pop up, but then the integrated Windows 7 on-screen keyboard will be activated when the *on screen keyboard button* is clicked.

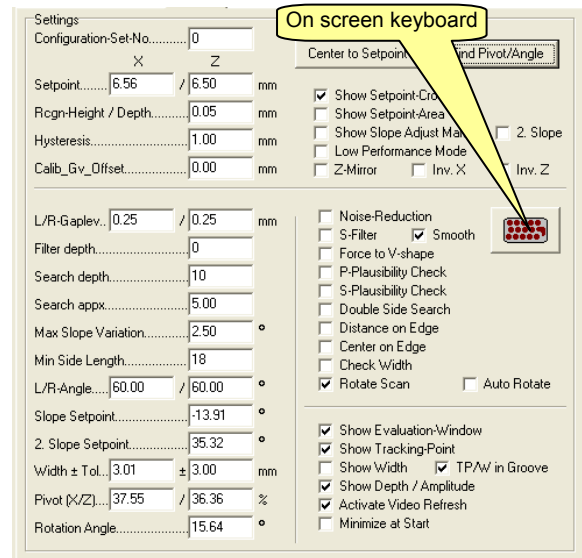

Parameter	Default value	Function
Configuration Set No	0	Custom program number with store and recall function
Center to Setpoint	-	Center to Setpoint* sets the current tracking point as "zero"
Find Pivot Angle		
Rcgn-Height / Depth	0.5	Threshold for seam evaluation = min Height / Depth
Hysteresis	½ Scanner x-range	Left/right Limits Tolerance (Hysteresis)
Calib_Gv_Offset	0	Fine tuning "cheat" parameter
Left Gap-Level	0.1 ... 5 mm	Recognition point at the left V profile
Right Gap-Level	0.1 ... 5 mm	Recognition point at the right V profile
Filter depth	0 ... 5 max. 20	Number of averaged scans by „inter-scan-filter“
Search depth	1 ... 25 max. 100	Number of profiles for centre calculation
Search appx.	1 ... 6 max. 20	Damping filter
Max. Slope Variation	0 ... 45 °	Max. tilt angle **
Min. Side length	8 ... 20	Min. number of pixels at side for profile recognition
Left angle	60°	applies only for v-groove seam tracking
Right angle	60°	applies only for v-groove seam tracking
Slope Setpoint	0°	Adjustment for fillet weld and other algorithms
2. Slope Setpoint	0°	Adjustment for fillet weld
Noise Reduction	OFF	Noise filter
S-Filter	OFF	Spark Filter Spline function
Smooth	OFF	Smoothing filter
Force to V-shape	OFF	Only for v-shaped grooves
P-Plausibility check	OFF	Plausibility check inside one scan profile
S-Plausibility check	OFF	Plausibility check in the seam, jumps over tack welds
DSS	ON	Double Side Search
Distance on Edge	OFF	Algorithm 10 : Z-Position is evaluated at the edges
Check width	OFF	Width check: width value +/- Width Tolerance
Rotate Scan	OFF	Rotate profile (static)
Auto Rotate	OFF	Rotate profile automatic (permanent, dynamic)
Show Evaluation Window	ON	Show / activate evaluation window
Show Tracking Point	ON	Show Tracking Cursor
Show Width	ON	Show width
TP/W in Groove	ON	Show Tracking Cursor and width
Show Depth / Amplitude	ON	Show depth and amplitude
Activate Video Refresh	ON	Activate Video Refresh
Minimize at Start	OFF	Minimize MelTrax user interface at start; useful when CPU performance should be saved

* Center to Set point helps to set up the machine in short time: adjust the scanner head mechanically in a way that the profile is centered in the display. Then click Centre to Set point. The center value is referenced as "zero".

** Surfaces with steeper angle are excluded from recognition.

When required, enter new values for **Left Gap-Level**, **Right Gap-Level** and **Hysteresis** according to the geometry of the real seam. Important is, that you adjust the parameters **Left angle** and **Right angle** according to the real seam. **Max Slope** is the maximum tilt angle to the horizontal, **Min side length** is the number of pixels at the side left and right which must be visible for a successful recognition.

click "STORE INI", before you leave, and MelTrax software will remember your settings at the next start. Without store ini, the settings are only valid until the software is restarted. Already stored ini files can be loaded with the "LOAD INI"-button.

Setpoint Crosshair is a thin grey line crosshair in the evaluation window. „*Show Setpoint-Crosshair*“ switches on the crosshair and makes visible where the system zero point is set.

„*Show Setpoint Area*“ shows the signal range of the center Hysteresis in the scan window. This makes it easier to make an educated guess about the output signal and dynamic behaviour of the machine movement.

„*Show Slope Adjust Marker*“ switches on the slope adjust help markers for easier adjustment of the slope angles.

Configuration Set No

This Option allows to store and recall custom system settings to a custom program number. The program number can be sent by a client to MelTrax or set up in the settings page of MelTrax.

Set up all parameters as required for your application. Then enter a program number in the edit box configuration Set No and click the store ini button.

MelTrax now saves two new ini files, numbered according to the configuration program name you gave them.

Show Setpoint Crosshair | Show Set point Area

The Setpoint Crosshair is a set of a horizontal and a vertical thin grey help lines indicating the center of the measurement window. With show Setpoint Crosshair the display of the center lines is enabled.

Show Set point Area switches on the hachures of the area outside of the hysteresis in the measurement window. This shows the set point adjustment.

Activate video refresh

The Checkbox „*Activate Video Refresh*“ switches on and off the graphic display of the scan profile. The option can be set via TCP/IP (Ethernet) from remote TCP clients. When the option is set to off, the CPU load is much less. This option may be useful, when the application is running on a low performance PC, remotely operated from TCP Clients. For the use on the iControl, we recommend to set „*Activate Video Refresh*“ to 0 = off. This will greatly reduce CPU load.

Minimize at Start

The option "Minimize at Start" sends the display to the task bar, the screen is available for a client (e.g. the Profibus client) to be visible. The option saves CPU load.

Low Performance Mode

 MelTrax Ver. 1.1.7s (Licensed to MEL)

The Low Performance Mode reduces stress for the CPU. This should help to run the application on older iControl hardware without heating up the CPU. When the low performance mode is active, in the *headline* of MelTrax the title string is marked with a "s" like *slow*. The reaction of the software *on screen* may *appear* slower, this is why MelTrax slows down screen updating, yet for mathematical treatment no profiles or results were dropped.

During test, we found that the CPU load on a 500 MHz CPU was reduced from 100 % to 40 ... 60 %, another reduction is made, when the MelTrax application is minimized to the task bar after start. This may reduce CPU load further to 30 ... 50 %. Keep in mind: CPU load will even raise when you even *move* the mouse or type the keyboard. For best performance minimize all visible windows and disconnect or do not use mouse and keyboard.

Dynamic averaging and dynamic system behaviour

The system records a number of profiles and averages the output to the D/A converter driving the analogue outputs 1...4. These outputs were driven with a delay, depending from the number of averaged scans. The Parameters *Search depth*, *Search appx*, *Filter depth* and *Plausibility* are responsible for this delay and the dynamic response of the system.

Search depth

Start up takes ½ second, when you have selected „*Search depth*“ = 20. When *Search depth* is a higher value, start up takes more time and the software will be slower in reaction to sudden changes.

Search appx. Search depth should be left at factory default = 5.

Filter depth

Filter depth is a tuneable low pass filter. Filter depth has an impact on the reaction of the system. *Filter depth* = 0 is the quickest reaction, this is the factory preset. When the system oscillates, increase filter depth from 1 ... 5.

P-Plausibility, S-Plausibility

The algorithms P- and S-Plausibility minimize the influence of unwanted signals to the dynamic behaviour of the system.

P-Plausibility inspects the profiles beneath the seam. Jumps are damped until a new stable value is found. The algorithm fades to new value. This avoids, that the machine motor is jumping or oscillating.

S-Plausibility inspects the profiles inside the groove. Profiles are damped until a new stable value is found. The algorithm fades to new value. This avoids, that the machine motor is jumping or oscillating.

When only tack welds are present it will be ok to enable S-plausibility.

Dynamic Filters: Noise Reduction, S-Filter, Smoothing

The filters help with difficult surface – rough, shiny, mirroring. Scintillating reflections create unwanted optical effects (Speckles). This is the source of noise on the scan profiles. This may cause stress for the servo motors and permanent reversing movement of the torch support. The motors may heat up.

The *Noise Reduction* filter acts like a classic noise suppressor with good dynamic reaction, yet some details get lost. The *Noise Reduction* filter reduces greatly the stress for the motor drives.

S-Filter applies a Spline Algorithm on the Scan profile. Strong signal peaks were removed and wavy profiles are flattened. S-Filter removes unwanted signals, yet it also removes details. S-Filter allows recognizing a profile, when unfiltered profiles are not detectable.

S-Filter rounds sharp edges, the gap appears wider
Smoothing rounds edges. For narrow gaps, smoothing is not recommended, use S-Filter instead.

Smoothing is a compromise between Noise Reduction and S-Filter. It is a bit of both, but has no further disadvantage. The effect of Smoothing is not as noticeable as the effect of S-Filter.

noise →	No noise	Some noise	Strong noise + sparks
Rated filter	No filter	Noise Reduction	S-Filter
Alternative Filter	Smoothing	Smoothing	S-Filter + Noise Reduction
Alternative Filter 2	Noise reduction	S-Filter	S-Filter + Smoothing

Please note: using filters is not always an advantage, and in worst case, filters can degrade the result.

When you receive no improvement after switching on the filter, better switch it off. The problem could be else where in the system. Before you start to experiment with the filters, consider if your scanner is set up in the best way. Check profile quality on screen and verify if optical effects can be disabled using simple methods or improvements in preparation of the groove. When the scanner set up is perfect, filters could bring an additional improvement. Please consider that filters do not only remove unwanted signals, they always will remove parts of the signals and details or the profile. When everything is perfect without arc and unwanted signals increase in the moment the arc is started, filters may help to reduce this effect.

Display control

“Show Evaluation Window” shows the active portion of the scan window. The red rectangle can be sized by dragging with the mouse, when “Show Evaluation Window” is selected. The part of the scan window inside the red rectangle is active and is considered for mathematical evaluation by the algorithms and filters, the area outside the red rectangle is not considered, and therefore disturbing elements can be “masked out” dragging the red rectangle to a good position.

do not make the evaluation window too small, the algorithms need some pixels to work correctly!

Set up	Required cursor setting
Show Evaluation Window	Shows the region of active evaluation, marked with a red rectangle, outside this area the profile is not recognised by the evaluation algorithm
Show Centre	Cross hatch cursor
Show Width	Width display
Show Depth	Step height display
Groove Width detection	Show TP/W in groove
Distance on Edge	Tracking point z calculated from edges
Center on Edge	Tracking point x is middle of edges

Always set Left angle and Right angle corresponding to the real seam geometry. Max Slope adjusts the angle to the horizontal. Min side length is the length of the straight part at the side of the groove in pixels.

Click “STORE INI”, when you leave the configuration screen to save the configuration. “LOAD INI” selects the saved configuration.

The Check boxes “Show Centre”, “Show Width”, “Show Depth” should not be activated all at the same time. Depending on the selected algorithm specific display make sense:

Measurement Routine	Display
Seam tracking	Show Width, Show Center
Groove detection	Show Depth, C/W in Groove
Seam inspection	Show Center

DSS / Distance on Edge

DSS stands for „double side search“. The algorithm searches beginning with the edges of the recognition area for tracking points and in the same time, the algorithm searches for tracking points beginning from the center to the edges of the scan window. Distance on Edge calculates the tracking point from the edges.

Activate video refresh

The checkbox „Activate Video Refresh“ switches graphic display on and off. This option can be controlled as well with a TCP remote client. With deactivated video refresh, CPU load is much less. This option makes sense, when you are running MelTrax on a weak PC and when you do not need a graphic display.

TP/W in Groove

The Checkbox „TP/W in Groove“ activates the display of groove width. This option is for measurement on screen.

Z-Mirror

With this option the profile can be inverted in the z-axis. The algorithms receive the inverted profile data, so algorithms which have originally not been designed for the actual profile may work with the inverted profile.

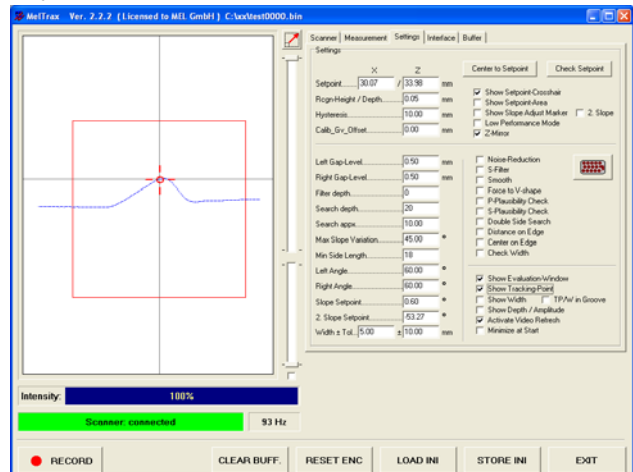
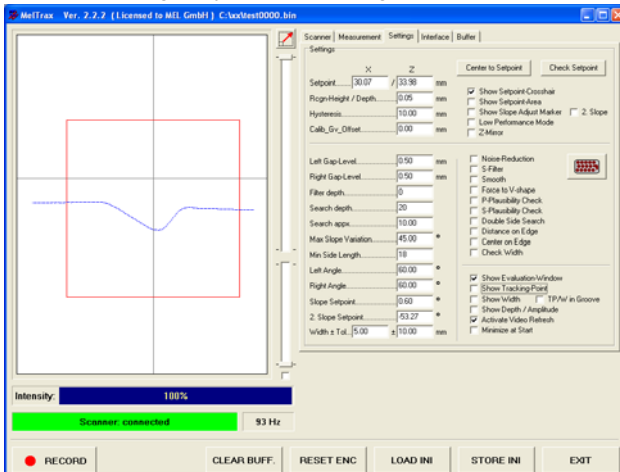

Invert-X; Invert-Z

Inv. X and Inv. Z checkboxes allow to invert the x and z polarity of the output signal on the data outputs.

Unlike Z-Mirror, the visual profile does not change!

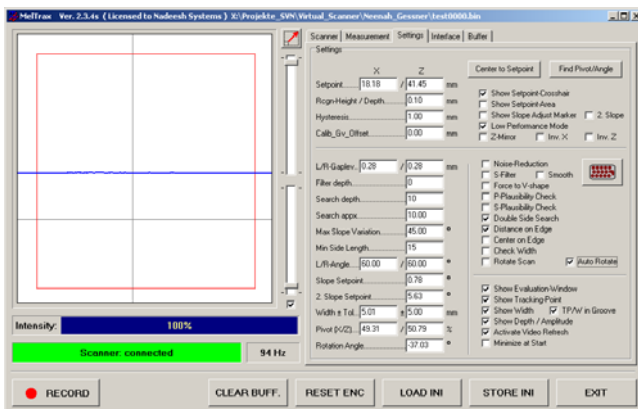
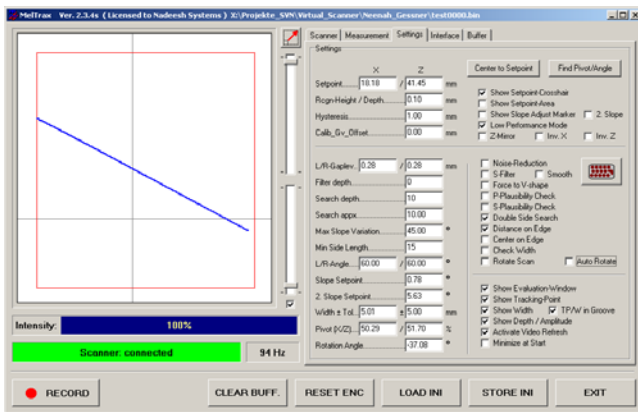

Find Pivot Angle

Find Pivot Angle helps to find quickly the „Rotation Angle“ and the coordinates of the profiles *center of gravity*.

The center of gravity is the rotate point used for the options „Rotate Scan“ or „Auto Rotate“.

Rotate Scan

Rotate Scan rotates the profile. When previously Find Pivot Angle the rotation point has been defined, the profile will be “flat”.

Rotation point and rotation angle are updated only when calling the option. When the rotate angle varies, it may be better to use the function *Auto Rotate*. The maximum angle compensation is limited by the value of “Max. Slope Variation”. This is valid for Rotate Scan and “Auto Rotate”.

Auto Rotate

Auto Rotate rotates the profile automatic. *Auto Rotate* permanently evaluates the angle of rotation and point of rotation in background.

When objects move fast, the *Auto Rotate* algorithm may not be able to follow fast enough. In this case it is better to use *Rotate Scan* as a static compensation of average tilt.

MelTrax Software Manual

Application of Rotate Scan / Auto Rotate

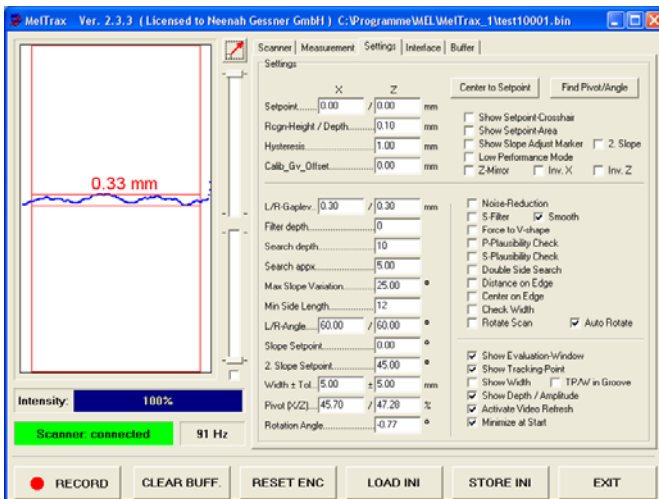

the screenshot on the left side shows an application of amplitude measurement on a structured filter paper.

Auto Rotate places the profile in a flat position, so that the amplitude algorithm's result is precise.

When the object moves fast, it may be wise to compensate the pivot angle with the static command "Rotate Scan". "Auto Rotate" in some cases makes the profile tremble. Use "Find Pivot Angle" to find the angle and "Rotate Scan" for correction.

Switch on "Auto Rotate" for a short time and switch it off again. After a few 100 Milliseconds, Auto Rotate has calculated the pivot angle. When you switch on now "Rotate Scan" the algorithm uses the found pivot angle saved in the system.

Technical background: the *Auto Rotate* Algorithm can not follow fast movements of the profile, this causes the profile to make jumps every time when the algorithm

has updated the pivot angle and draws the new (rotated) profile.

Record

The record button switches on record with the first click and switches off with the second click. When recording has been activated, the record button changes into STOP. The recorder records binary files. Record stops only, when you click the button STOP. In case, record will write to disk unless the disk is full,- and then you may have a problem!

never activate record when you are in production!



Recorded files can be played back with *VScanner*, details on [page 43](#).

Otherwise the software module *View3d* can create a 3-dimensional graphics on screen.

Reset default Scanner settings

1. Click Reset Head
2. Click Get Values
3. Default values of Scanner are shown

Best adjustment for Scanner Settings

Const. Intensity = OFF = Automatic mode
 Laser Power = adjust for 100% intensity
 Video Gain = if not in automatic mode, set lowest possible



Intensity pixel representation should be higher than the lower third of profile window. In the screenshot of our example, the utter left and right portions of the profile are too low in intensity.

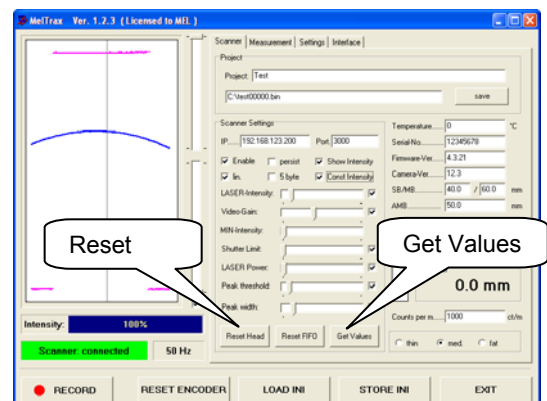

Optimize Performance

MelTrax will not cause high amount of CPU load on a PC with 3 GHz Dual Core CPU with Windows XP, Vista or Windows 7. Yet on weak PCs with less power it is recommended to shape power for best response for MelTrax and its clients. Therefore activate the following settings:

- | | | |
|-------------------------|------------|--------------------|
| 1. Buffer | disable | |
| 2. Minimize at start | activate | MelTrax and Client |
| 3. Low performance mode | activate | |
| 4. Video refresh | deactivate | |
| 5. Profile continuous | disable | for all clients |

Selection Client

The Selection Client is made for quick change of pre set programs. All parameters, definitions, thresholds and pre set conditions of the software, as algorithm, language, parameter, are set on the click of a button. The network connection is made like with all other clients over port 3100. The program settings must be defined and saved in MelTrax main application.

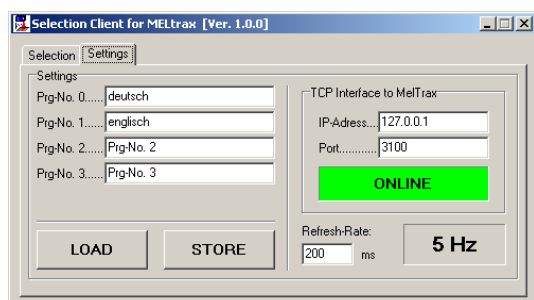

Interface

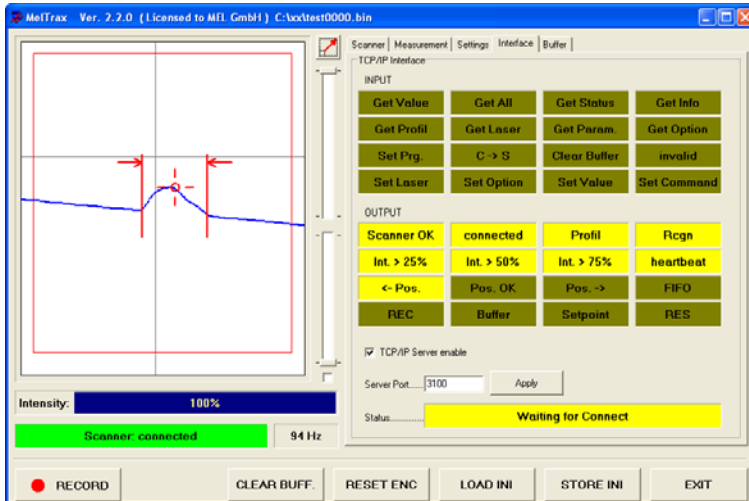

The interface screen displays the input, output signals, recognition signals and connection status of TCP clients. Here the communication port for MelTrax clients is set. Only when „TCP/IP Server enable“ check box has been set, MelTrax communicates with the clients.

On this tab the most important status signals are shown with „LED’s“. These are lit in yellow colour, when the corresponding status signal is activated.

When no client is connected to MelTrax the status display shows „waiting for Connect“ in yellow colour, when a client has connected the display changes to green and shows „1 client connected“. When more clients are connected, the number of clients is shown accordingly. Although only a limited number of status information can be displayed on the interface

tab, all status information are available to external clients over the command line interface.

For monitoring, the TCP-Client can be used to visualize the wanted status information.

On the interface tab no adjustments must be made, except the server port. For normal set up, default settings should be ok. For special set up, MEL delivers dedicated technical information.

Status information shown on screen:

1. extern commands to MelTrax command line interface; ex.: TCP-Client or Profibus-Client		
Parameter	Meaning	Value / Signal condition
Get Value	Get value of a parameter	See chapter <i>command line interface</i>
Get All	Get all values of active parameter	See chapter <i>command line interface</i>
Get Status	Get Status information	See chapter <i>command line interface</i>
Get Info	Get Info	See chapter <i>command line interface</i>
Get Profil	Get Profile	See chapter <i>command line interface</i>
Get Laser	Get Laser values	See chapter <i>command line interface</i>
Get Param	Get Parameter	See chapter <i>command line interface</i>
Get Option	Get Option	See chapter <i>command line interface</i>
Set Prg	Set algorithm	See chapter <i>command line interface</i>
C -> S	Center to Setpoint	Set tracking point to zero (calibrate)
Clear Buffer	Clear Buffer	Erase buffer contents
invalid	-	
Set Laser	Adjust Laser parameters	Change laser settings (caution!)
Set Option	Set Option	See chapter <i>command line interface</i>
Set Value	Set value	See chapter <i>command line interface</i>
Set Command	Send command	See chapter <i>command line interface</i>
2. MelTrax output signals ; ex.: to TCP-Client or Profibus-Client		
Parameter	Meaning	Value / Signal condition
Scanner OK	Hardware Status M2-Scanner	Hardware works correctly
Connected	Connection to Scanner = OK	MelTrax Software is connected to Scanner
Profil	Scanner profile is available	The Scanner „sees“ at least a few pixels of a profile
Rcgn	Recognition = OK	Condition for mathematical evaluation with algorithms
Int. > 25%	Laser-Intensity > 25%	The Scanner should be cleaned and checked
Int. > 50%	Laser-Intensity > 50%	The Scanner should be cleaned
Int. > 75%	Laser-Intensity > 75%	The Scanner should be cleaned
Heartbeat	Toggle signal	Shows that MelTrax Software is “alive”
< - Pos.	Position too left	Switching signal for 2-point regulator
Pos. OK	Position in the Hysteresis range	Switching signal for 2-point regulator
Pos. ->	Position too right	Switching signal for 2-point regulator
FIFO	Fifo memory full	Performance problem
REC	Recording is active	Scan profiles are recorded
Buffer	Buffer	Indicates if buffer is active
Setpoint	Stored zero point	Center to Setpoint calibrates the machine
RES	Reserved	Spare

Buffer

The Buffer screen displays parameters over time. The vertical blue cursor line represents the time / position of the output signal. The position of the scanner corresponds to the left border of the buffer window. Depending on the speed of rotation, the recognised tracking cursor position should reach the motor amplifier at the time where the scanned position on the metal surface has reached the torch position. The blue line represents the position or time of the outputs. Depending on the setting in the lower right part of the Buffer window, MelTrax takes either Time, Scanner or Ethernet coordinates as reference for the movement. The incoming parameter data appears at the left border of the window and goes to the right side, depending from the movement parameter. When the buffer is not used, set it to "disable"

Parameter	Function
X-Tracking	Center position
Z-Tracking	Distance
Left Z	Left Distance
Right Z	Right Distance
Z difference	left – right z
Width	Groove Width
Slope	Slope of sheet
Left Angle	Left angle
Right Angle	Right angle
X-Angle	Enclosed angle
Seam height	Seam height
Left groove	Left angle
Right groove	Right angle

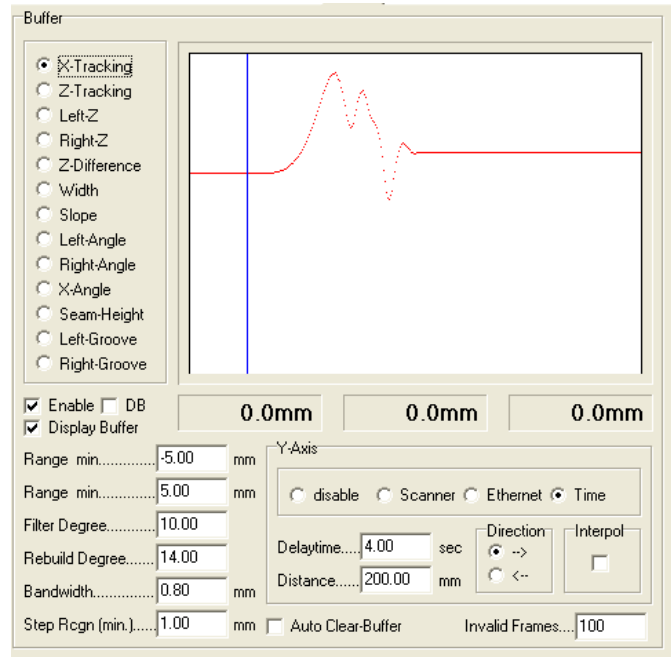

The position of output can be adjusted with the edit boxes "Delay time" and "Distance". This setting should match with the real torch position.

Range is scaling the display of the monitored parameter.

Example:

Scanner: M2-iL2-120/60/80

Selected parameter: X-Tracking = x coordinate of tracking point
 Range min: -5
 Range max: 5
 → The center cursor tracking point is shown in the range of -5 to +5 mm.



Positive values are shown without sign!

The behaviour of the graph depends on speed of movement, setting of range, setting of the filter parameters in the buffer configuration screen (see below).

Auto Clear Buffer

In some applications, we found that "Auto Clear" helps to keep the data in Buffer consistent. When the scanner is moving over an undefined surface, before the measurement is started, the Buffer collects "rubbish". This could cause a unwanted shift in starting position.

Integration filter

The integration filter is active when the checkbox "enable" has been activated. With the help of an integration filter the output signal is "sweetened". This reduces stress to motors, motor amplifiers and the whole mechanical guiding system.

Default settings:
 Filter Degree = 10
 Reguild Degree = 10
 Bandwidth = 1

Step Rcg (min) is not active.

The switch *Direction* is for matching of Encoder data to the direction of mechanical movement.

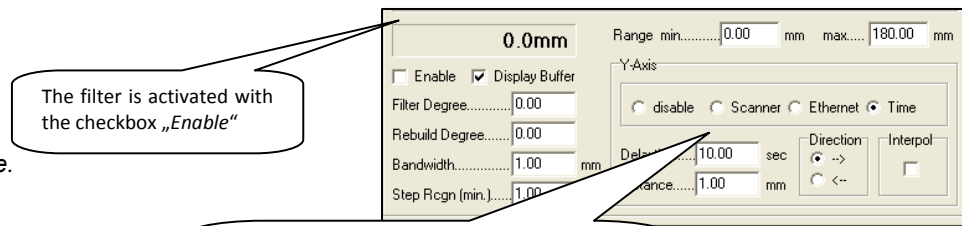

TCP Client

The TCP Client is a piece of standalone software for connecting from external PC's to MelTrax software.

The MelTrax-TCP Client may be used to remotely operate, set up and control MelTrax software on another PC in the network.

TCP Client can be used on different PC's accessing to the same MelTrax software instance. For data exchange with Clients, MelTrax software needs to be registered and unlocked, the clients need no license.

When MelTrax is not licensed, you may send commands from TCP Client to MelTrax, but you will not receive back any data, status messages or measurement results from MelTrax to the TCP Client. Details on registration are given on page 42.

On the *Laser* screen, the record function of MelTrax can be started with a click on the red **REC** button, and it can be stopped with a click on the **STOP** button.

The same can be done with the two commands
SCSTAR +CR = Start Recording
SCSTOP +CR = Stop Recording
 over TCP/IP, as for example from a TCP Client.

The syntax of the TCP commands is given in the following pages. This is also valid for the built in command line interface (which is on the client screen, see next page).

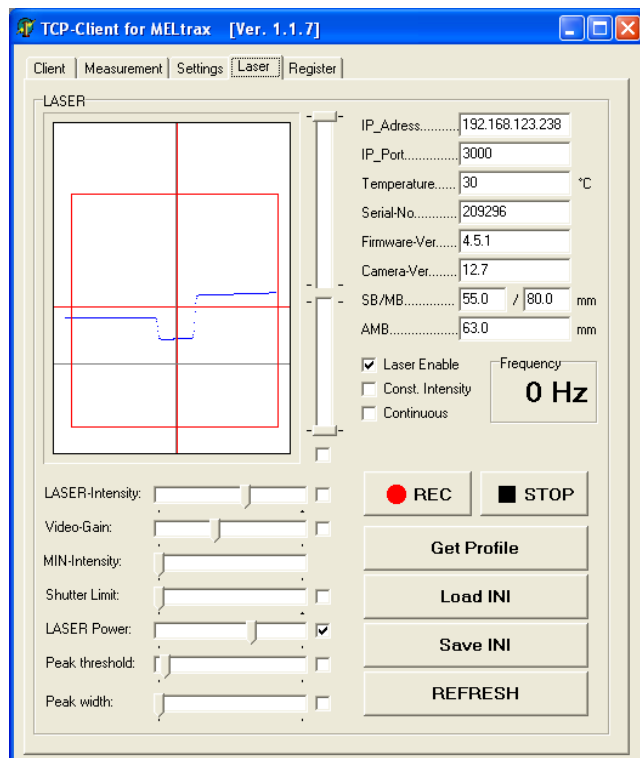

Client screen

To enable the communication, the MelTrax software must be set up to "allow" communication. This is made by activating the checkbox "TCP/IP Server enable". By default the server port is set to 3100.

In the Client screen, the IP address and the port must be set to the IP address of the PC on which MelTrax software is active. When MelTrax is running on the same PC as the client, the IP address of the "localhost"* 127.0.0.1 is set up.

In or example the sending device is the PC 192.168.123.71; the port is set to 3100 (default).

When these settings are done, click the "Connect" button on the lower left. The connection will be established; the connection indicator will turn to green and say "ONLINE". The connect button changes to "Disconnect".

The Command line interface can be used to send commands to the MelTrax software. The syntax is given further below in the chapter "Command line interface".

The buttons Load INI and Store INI allow to save (store) and reload (load) the settings to the clients Tconfig.ini file.

Exit ends the Client software, the remote button turns down the PC on which MelTrax is running.

* localhost is a basic network service available on all Windows and Linux PC's.

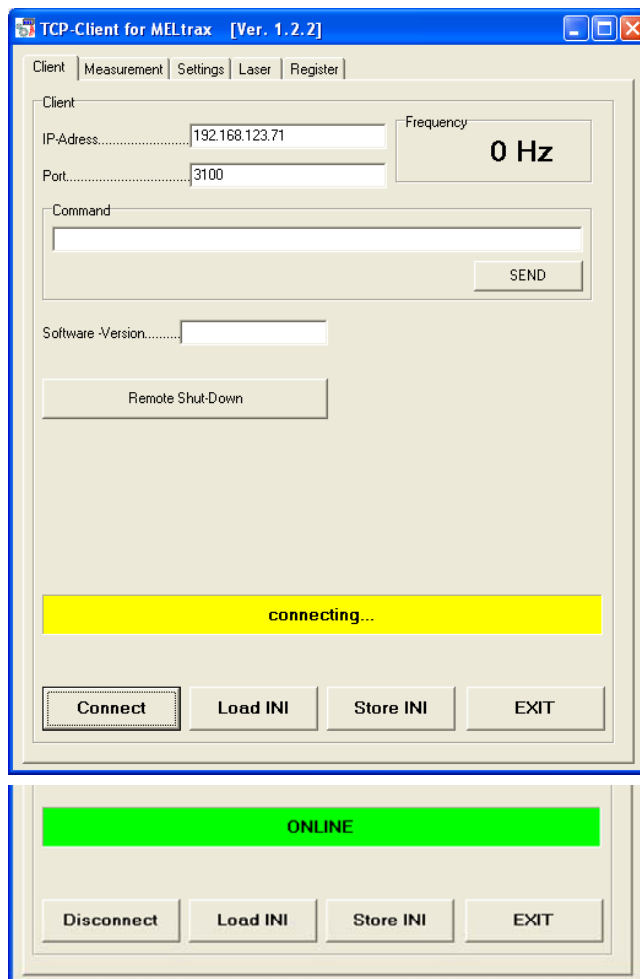

Measurement

On the Measurement screen the selection of the algorithm can be set up. Also the measurement results are displayed. This allows easy remote control of the application from remote PCs in the network.

For continuous updating of the measurement results, the option "Continuous" must be activated. When the option is activated, the client continuously requests a from MelTrax. The following parameters are displayed in the Measurement tab:

- Center = Tracking-X
- Distance = Tracking-Z
- L-Distance = Left height
- R-Distance = Right height
- Z-Difference= Height difference
- Width = Width of seam
- Slope = Average angle of slope
- L-Angle = Left side angle
- R-Angle = Right side angle
- X-Angle = Angle between left and right side
- Seam Height= height of the seam
- L-Groove Depth= left groove depth
- R-Groove Depth= right groove depth
- Encoder = Encoder position [mm]

The yellow LED's at left from the parameter names are lit when the parameter is active. Inactive are those which LED's is dark.

Settings

Settings are almost the same as in the MelTrax main software application.

Settings which are only relevant for the screen display control of MelTrax main screen display have been left out on the TCP client. For all other settings the meaning and the function is identical. Commands, which are not available in the Client, can be accessed with the command line interface, a really powerful tool!

The Command line interface

From the command line – see screenshots on the previous page – commands can be sent to the MelTrax software. The TCP_Protokoll.txt describes the syntax and the command set of the command line interface.

Commands can be sent either from TCP clients or directly from a PLC. Alike the other commands, on the command line interface, there is no priority for any client and all clients have the "same rights"; the PLC is acting also as one of the (many) clients.

The S7 Test-Project

For the support of PLC software engineers, MEL has created a Test project for demonstration of the command line's capabilities. Siemens Step7 V5.4 SP5 has been used.

The meaning of the Test project was to demonstrate the data transmission from S7 PLC to MelTrax and back.

The Test project should be the basis for integration into the PLC application modules. The PLC software engineer receives a module performing the data transport layer which helps to send commands from the PLC to MelTrax, reads out status, results and parameter data from MelTrax.

The S7 Test project makes only the transport layer of data communication. A Ethernet network connection between PLC and MelTrax PC is required. Our PLC is the CPU Type ET200S (IM151-8 PN/DP). Other PLC's of the S7 family may be used, but the *CPU identifier* must be set according to the specifications of the CPU. More details are given in the project examples later.

The PLC software engineer must write and install additional software modules on his PLC to integrate the data received on the PLC into his application. The following examples describe the visualisation of data and the syntax of the telegrams.

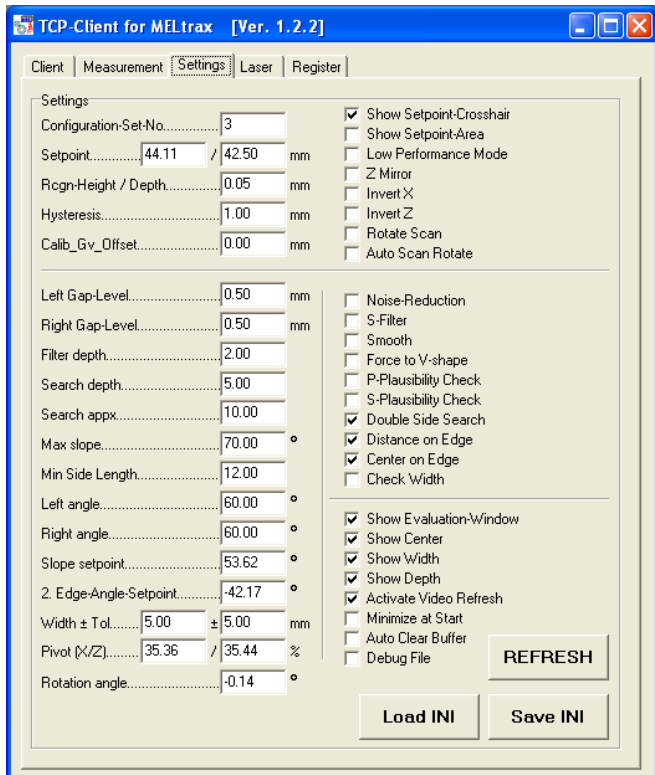
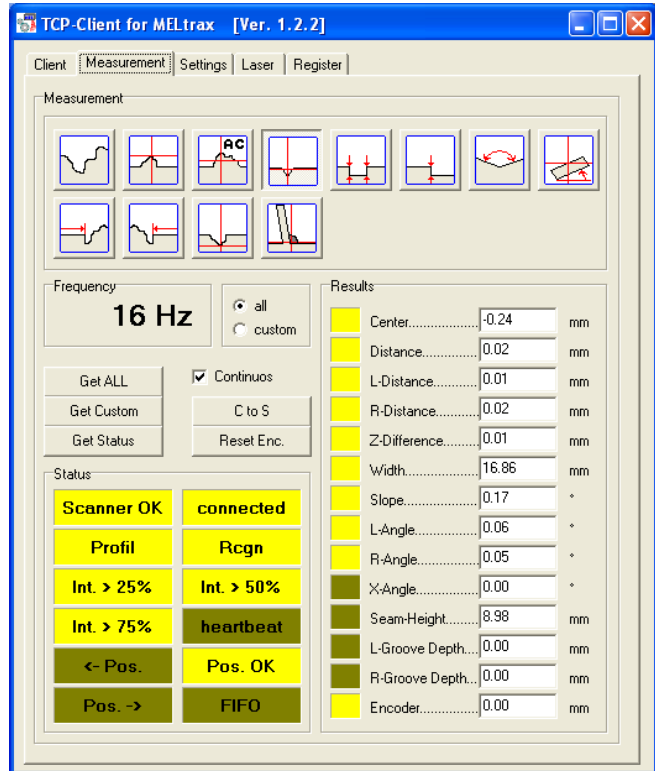

MelTrax Software Manual

TCP_Protokoll.txt is a listing of all commands of the command line interface. On the next pages, we have made a table with all these commands to show the syntax in details.

1. Command set and Syntax

When the command line of the TCP_Client is used, no formatting characters must be used. In this case, only the pure command, without the terminating Carriage return character 0x0D (hex) must be given. With Enter or a click on the send button, the command is sent out. Example: GV00 [Enter]

When a command is sent from the PLC, then a Carriage return must be sent at the end of the command string: example: GV00Cr [Cr ist our abbreviation for the Carriage return character 0x0D]

Some examples are given in the following chapter „S7 Client Test-Project“.

When MelTrax receives incomplete or faulty commands, the command is ignored and the previous status is maintained. MelTrax expects integer, natural numbers for parameters, configuration Set No. and coordinates. Example: program number could be transferred as 0,3 or 0.3; in both cases, MelTrax will interpret such a number as 0. Leading 0's are ignored: Configuration Set No. 000005 is interpreted as 5.

Flexibility

The command set for TCP clients has more elements as the Profibus client interface ever had. This development is historic, and as we realize, that new PLC's all provide Ethernet connection, we found no good reason not to develop a even mightier interface than Profibus: Ethernet / TCP. In a short time many improvements have been made to introduce new clients all based on Ethernet. This was the reason, that we could develop quickly new features for our customers with a unified set of software modules. Our aim is to provide all new solutions on the Ethernet basis, while maintaining Profibus for those who still need it.

Custom Values

The command set is so mighty, so we felt for some applications only a few parameters will be relevant which could be requested in a simpler way. The command GVC, "get values custom" gives the possibility to mark the relevant parameters in the Xconfig.ini file and get those parameters with a simple command: GVC[Cr].

The parameters, which are marked with =1 inn the Xconfig.ini file are transferred to the requesting client. All marked parameters are transferred, in the sequence as they are listed in the XConfig.ini file. The transfer starts with the first parameter Centre, which has the internal count=0.

The count of parameter starts

The command string **GVC**

Values, which are handed over to MelTrax after a command „GVC“ from one of the clients, are marked in the Xconfig.ini File with =1.

Example : this is how the Xconfig.ini File looks:

```
...
[Custom Values]
Center=1
Di stance=1
L-Di stance=0
R-Di stance=0
Z-Di fference=0
Wi dth=1
Sl ope=1
L-Angl e=0
R-Angl e=0
X-Angl e=0
Seam_Hei ght=0
L-Groove_Depth=0
R-Groove_Depth=0
Encoder=0
Status=1
...
```

This configuration of XConfig.ini makes MelTrax to transfer the result values of:

- Center (x-coordinate)
- Distance (z-coordinate)
- Width
- Status

The complete table „Get Values Custom“ is given further below.

2. the command set

The Tables on the following pages are the commands for MelTrax software Version 2.3.8

Character description = Carriage return (0x0D; hexadecimal)

2.1 Select Algorithm

Only *one* Algorithm can be selected at a time.

Set-Befehle	Prog	Meaning		
SM00	00	Profile (no algorithm)	none	Measurement programs
SM01	01	Highest point	max. height	
SM02	02	Area centroid	area centroid	
SM03	03	Seam tracking	seam	
SM04	04	Groove measurement	groove	
SM05	05	Step / edge	step	
SM06	06	Enclosed angle	X-angle	
SM07	07	Slope edge	slope/edge	
SM08	08	Left edge	left edge	
SM09	09	Right edge	right edge	
SM10	10	Deepest point	lowest point	
SM11	11	Fillet weld	fillet weld	
SM12	12	Amplitude	Minimum and maximum	
SCTS	TS	Center To Setpoint	Calibrate the machine	controls
SCRE	RE	Reset Encoder		
SCRB	RB	Reset Buffer		
SCLI	LI	Load ini file	Load-INI-File	
SCSI	SI	Save ini file	Save-INI-File	
SCSTAR	STAR	Start recording	Start Recording	
SCSTOR	STOR	Stop recording	Stop Recording	
SCSHD	SHD	Shut down PC	Shut Down	
SCSSG	SSG	Set simple GUI on	Switch on simple Display	
SCSNG	SNG	Set simple GUI off	Switch back to normal Display	

2.2 Set Value

example: SVxx>12.34 Set Value xx to 12.34

Set-commands		Meaning	Parameter	Range	
SV26>NNNN	26	Position of eval window x left	Eval.Window Min_X	(0..4095)	Program settings
SV27>NNNN	27	Position of eval window x right	Eval.Window Max_X	(0..4095)	
SV28>NNNN	28	Position of eval window z low	Eval.Window Min_Z	(0..4095)	
SV29>NNNN	29	Position of eval window z high	Eval.Window Max_Z	(0..4095)	
SV30>NNNN	30	Tolerance for too left / too right	Center hysteresis	[mm]	
SV31>NN.NN	31	Zero of tracking point x	Setpoint_X	(0..SB)	
SV32>NN.NN	32	Min height threshold	MinHeight	[mm]	
SV33>NN.NN	33	slope	Angle_Setpoint	(-89°..89°)	
SV34>NN.NN	34	Offset for groove depth (cheat)	Groove Calib Offset	(-10..10mm)	
SV35>NN.NN	35	Left side tracking point	Left Gap Level	(0..MB)	
SV36>NN.NN	36	Right side tracking point	Right Gap Level	(0..MB)	
SV37>NN.NN	37	Filter depth	Filter Depth	(0..20)	
SV38>NN.NN	38	Search depth	Search Depth	(0..100)	
SV39>NN.NN	39	Approximation factor	Search Appx	(0..20)	
SV40>NN.NN	40	Max slope left side	Max Slope	(0..45°)	
SV41>NN.NN	41	Min. Profile Length at side	Min Side Length	(3..100 Pts)	
SV42>NN.NN	42	Left angle	Left Angle	(0..90°)	
SV43>NN.NN	43	Right angle	Right Angle	(0..90°)	
SV44>NN.NN	44	Zero tracking point Z	Setpoint_Z	(0..MB)	
SV45>NN.NN	45	Max slope right side	2. Edge-Angle_Setpoint	(-89°..89°)	
SV46>NN.NN	46	Set value for width	Width Setpoint	[mm]	
SV47>NN.NN	47	Set value for width tolerance +/-	Width Tolerance	[mm]	
SV48>NN.NN	48	Configuration Set No.	Program number		
SV49>NN.NN	49	-	-		
SV50>NN.NN	50	Auto Clear Buffer Invalid Frames	Number of invalid frames until Auto Clear		

2.3 Set Laser – Einstellungen für den Laser-Scanner

SLxx>12.34 Set Laser-Setting to 12.34

SLxx	xx		Example range of values	Scanner parameters
SL10>nnn.nnn.nnn.nnn	10	Scanner IP-Adress	SL10>192.168.100.010	
SL11>nnnn	11	Scanner TCP-Port	SL11>3000	
SL12>nnnnn	12	Encoder Counts	per meter	
SL13>nnnn	13	Laser Intensity *	(0..1023)	
SL14>nnnn	14	Video Gain	(0..1023)	
SL15>nnn	15	min. Intensity	(0..255)	
SL16>nnnn	16	Shutter Limit	(0..1023)	
SL17>nnn	17	Laser Power	(0..127)	
SL18>nnn	18	Peak Threshold	(0..127)	
SL19>nnn	19	Peak Width	(0..127)	
SL20>nn	20	Start CCD	(0..94)	Limit vision range
SL21>nn	21	End CCD	(0..94)	

* *Laser Intensity* can be set only, when the Scanner has been set to *Non-Automatic Mode*. This is the case when the Option „Constant Intensity“ is activated..

2.4 Set Option

SOxx+ = Enable Option xx Sox- = Disable Option xx
 Sox commands are switching commands: + switch on, - switch off.

Soxx + / -	xx			
SO10+	10	Connect Laser Scanner		Make connection
SO11+	11	Constant Intensity		Scanner configuration
SO12+	12	Scanner Linearisation		
SO13+	13	5byte Data format	For all M2-iLAN Scanners*	
SO14+	14	Noise Reduction		Filter settings
SO15+	15	S-Filter		
SO16+	16	Smoothing		
SO17+	17	V-Force		
SO18+	18	R-Plausibility		
SO19+	19	S-Plausibility		
SO20+	20	Double Side Search		Often required
SO21+	21	Show Center	Local Video Option**	Only for local graphic display
SO22+	22	Show Width	Local Video Option	
SO23+	23	Show Depth	Local Video Option	
SO24+	24	Show Evaluation Window	Local Video Option	
SO25+	25	Activate Local Video		Optimize performance : switch local video off and minimize for automated systems
SO26+	26	Minimize at Start		
SO27+	27	Show Centerline	Local Video Option	Only for local graphic display
SO28+	28	Show SetPoint-Area	Local Video Option	
SO29+	29	Low Performance Mode	Slower screen update	Optimize performance, saves CPU load
SO30+	30	C/W in Groove	Local Video Option	Only for local graphic display
SO31+	31	Show Intensity	Local Video Option	
SO32+	32	Distance on Edge		configuration of measurement function, see MelTrax software manual!
SO33+	33	Check Width		
SO34+	34	Center on Edge		
SO35+	35	Z-Mirror		
SO36+	36	Invert X		
SO37+	37	Invert Z		
SO38+	38	Rotate Scan		
SO39+	39	Auto Rotate		
SO40+	40	Auto Clear Buffer		
SO41+	41	Debug File		

1. switching 4 / 5 Byte data format is only for legacy hardware Rev.3. M2-iLAN Scanners have only 5 Byte data format.

** “Local video options” are such who are only important for the local video display on the PC on which MelTrax is running – this means they are not important for the client. In general we recommend using the option “minimize at start” with the MelTrax installation and initial configuration, so you will not have “local video” at all.

The command *Debug File* writes a text file to the directory. This file is for diagnosis. Activate this option only when requested by MEL.

Example of a Debug File:

```

09:24:41 0.00   ýb2   V02A>+000.21   V03A>-000.11   V04A>+000.32   C1279M03
09:28:21 0.00   ýb2   V02I>+000.21   V03I>-000.11   V04I>+000.32   C1279M01
09:46:07 0.00   ýb%   V00A>+002.70   V01A>-002.86   C0511M03

ýb2 / ýb% => Header + Length!
    
```

3. Client request















































The minimum length of the values is 7 Bytes, Encoder = 9 Bytes. Strings could be longer!

3.1 Get commands

Get commands get parameters from MelTrax. Characters are ascii





GVA>y.y;x.x;z.z;v;  -> Get Values **All** : all values and Status are transferred

GVxx>y.y;x.x;z.z;v;  -> Get Value xx : a single value is transferred

Client request	Request always terminates with Carriage Return CR (ASCII 13)	L	Data format	
GV00 	00 X-Tracking Point [mm]	7	+000.00	Measurement values
GV01 	01 Z-Tracking Point [mm]	7	+000.00	
GV02 	02 L-Distance [mm]	7	+000.00	
GV03 	03 R-Distance [mm]	7	+000.00	
GV04 	04 Z-Difference [mm]	7	+000.00	
GV05 	05 Width [mm]	7	+000.00	
GV06 	06 Slope [°]	7	+000.00	
GV07 	07 L-Angle [°]	7	+000.00	
GV08 	08 R-Angle [°]	7	+000.00	
GV09 	09 X-Angle [°]	7	+000.00	
GV10 	10 Seam-Height [mm]	7	+000.00	
GV11 	11 L-Groove Depth [mm]	7	+000.00	
GV12 	12 R-Groove Depth [mm]	7	+000.00	
GV20 	20 Encoder Value [mm]	9	+00000.00	
GV26 	26 Eval.Winwow Min_X(0..4095)	7	+000000	
GV27 	27 Eval.Winwow Max_X(0..4095)	7	+000000	
GV28 	28 Eval.Winwow Min_Z(0..4095)	7	+000000	
GV29 	29 Eval.Winwow Max_Z(0..4095)	7	+000000	
GV30 	30 Center hysteresis [mm]	7	+000.00	
GV31 	31 Setpoint_X [mm]	7	+000.00	
GV32 	32 MinHeight [mm]	7	+000.00	
GV33 	33 Angle_Setpoint [°]	7	+000.00	
GV34 	34 Groove Calibration Offset [mm]	7	+000.00	
GV35 	35 Left Gap Level [mm]	7	+000.00	
GV36 	36 Right Gap Level [mm]	7	+000.00	
GV37 	37 Filter Depth	7	+000000	
GV38 	38 Search Depth	7	+000000	
GV39 	39 Search Appx.	7	+000000	
GV40 	40 Max Slope [°]	7	+000.00	
GV41 	41 Min Side Length [ProfilePoints]	7	+000000	
GV42 	42 Left Angle [°]	7	+000.00	
GV43 	43 Right Angle [°]	7	+000.00	
GV44 	44 Setpoint_Z [mm]	7	+000.00	
GV45 	45 2. Edge-Angle_Setpoint (-89°..89°)	7	+000.00	
GV46 	46 Width Setpoint [mm]	7	+000.00	
GV47 	47 Width Tolerance [mm]	7	+000.00	
GV48 	48 Parameter Configuration Set No [number]	7	+000.00	
GV49 	49 -	7	+000.00	
GV50 	50 Auto Clear Buffer Invalid Frames [number]	7	+000.00	
GL23 	22 Temperature in °C		33	
GL23 	23 Serial No.		1210456	
GL24 	24 Scan-Range SBE		40.0	
GL25 	25 Measurement Range MB		60.0	
GL26 	26 Distance to Measurement Range AMB		53.0	
GL27 	27 Firmware Version		4.6.0	
GL28 	28 Camera Version		12.7	
GL29 	29 Software Version		2.3.2	

Hint: the . (point) is a character like 0 or any other character. The length may vary dynamically, with parameter 37, 38, 39 and 41 6 Characters are transferred without a point. Format is sign+float
 Diagnose values are natural numbers, with point, as shown in the data format column.

3.2 Get Values custom

Get custom Befehl		
GST 	Get Status	Examples of response telegrams are given below
GPA 	Get All Parameters	
GLA 	Get All Laser-Settings	
GOA 	Get All Options	

GVC  -> Get Values Custom (defined in the ini-File) as shown in the example on the first page.

Optional transfer of values with the commands GVA or GVC or GVxx the *request-* or *put string* characters of additional parameters is >y.y;x.x;z.z;v;

y.y=123.45 coordinate for travelling path

x.x=123.45 Offset added to X-coordinate

z.z=123.45 Offset added to Z-coordinate

v=0 valid v=1 not valid, no measurement is carried out

2. Answer from MelTrax to the Client

MelTrax must be licensed in order to transfer data to the clients. When this is not the case, MelTrax will receive commands, yet the single response will be >>EVALUATION COPY<<; data and status will be not available.

Structure of Answering Telegram

Example with 3 Result Data and Status

FF FE Header (hex)	XX YY Length (hex)	D 1 =13 ascii Characters	D 2 =13 ascii Characters	D 3 =13 ascii Characters	Status =10 ascii Characters
-----------------------	-----------------------	-----------------------------	-----------------------------	-----------------------------	--------------------------------

The length in this example is calculated from the end of the header = 2 Bytes + 49 Bytes;

1 Character = 1 Byte

The resulting length is 51 Bytes.

Please note: this calculation is true for the newer program versions with Enable_16bit_Status=1; for older program version Enable_16bit_Status=0, the status is 1 Byte shorter!

Enable_16bit_Status=0 → C0000M00 (down compatible to Ver. 1.x.x)

Enable_16bit_Status=1 → C00000M00

First 4 Bytes:

FF FE Telegram Header (hex)

XX YY 2 Bytes Telegram Length + 2 (inkl. Telegram length Bytes, but without Header-Bytes)

When MelTrax is not licensed:

V00A>+001.23  // Value 00 (=Center) Active (in selected algorithm) 1.234 mm

V00I>+001.24  // Value 00 (=Center) InActive (in selected algorithm)

C00000M00  // Status=00000, Measurement program=00

The 5 characters after the „C“ are a decimal number. In order to see the single bits, decode the number.

Decoded Status:

Bit 0 (1)	-> Scanner OK	
Bit 1 (2)	-> Scanner connected	
Bit 2 (4)	-> Profil	
Bit 3 (8)	-> Recognition OK	
Bit 4 (16)	-> Intensity > 25%	
Bit 5 (32)	-> Intensity > 50%	
Bit 6 (64)	-> Intensity > 75%	
Bit 7 (128)	-> Heartbeat	
Bit 8 (256)	-> Position too right	
Bit 9 (512)	-> Position OK	
Bit 10 (1024)	-> Position too left	
Bit 11 (2048)	-> FIFO load, performance problems	
Bit 12 (4096)	-> Recording	
Bit 13 (8192)	-> Buffer Cleared	(only with Enable_16bit_Status=1)
Bit 14(16384)	-> Position Centered	(only with Enable_16bit_Status=1)
Bit 15(32768)	-> reserved	(only with Enable_16bit_Status=1)

When MelTrax is not licensed: >>EVALUATION COPY<<

Open project

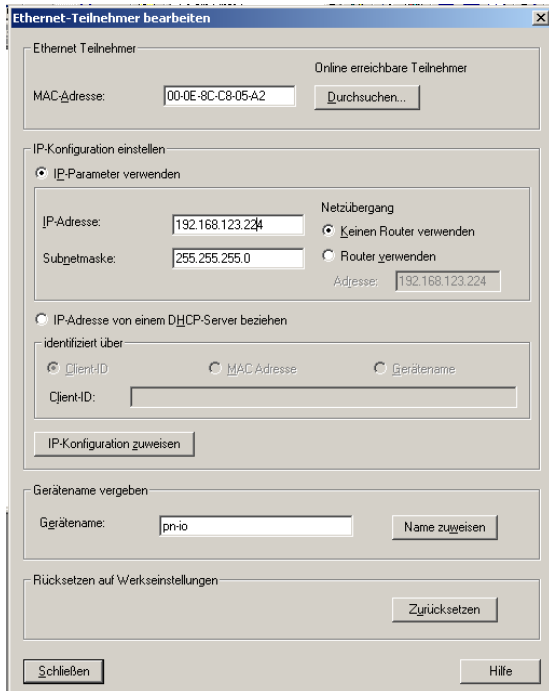
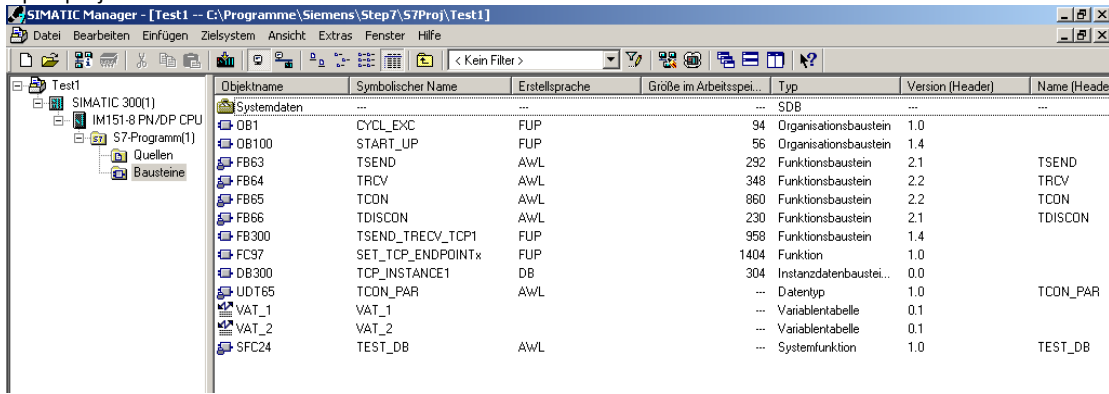

Here we must set search for available stations.
Then we set up the IP address of the PLC. In our case it is set to 192.168.123.224

You may give a name to the station – ours is pn-io

Then we must define the remote port and the IP-Address of the CPU: open FB 300!

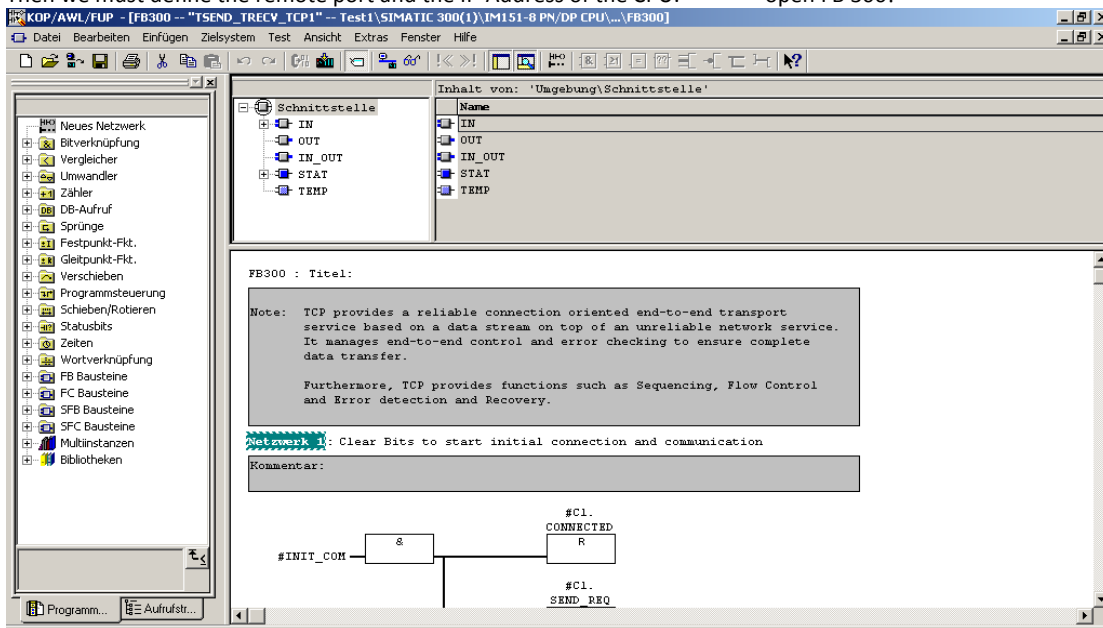

In FB300: define Machine ID of PLC and IP address scroll down to module FC97

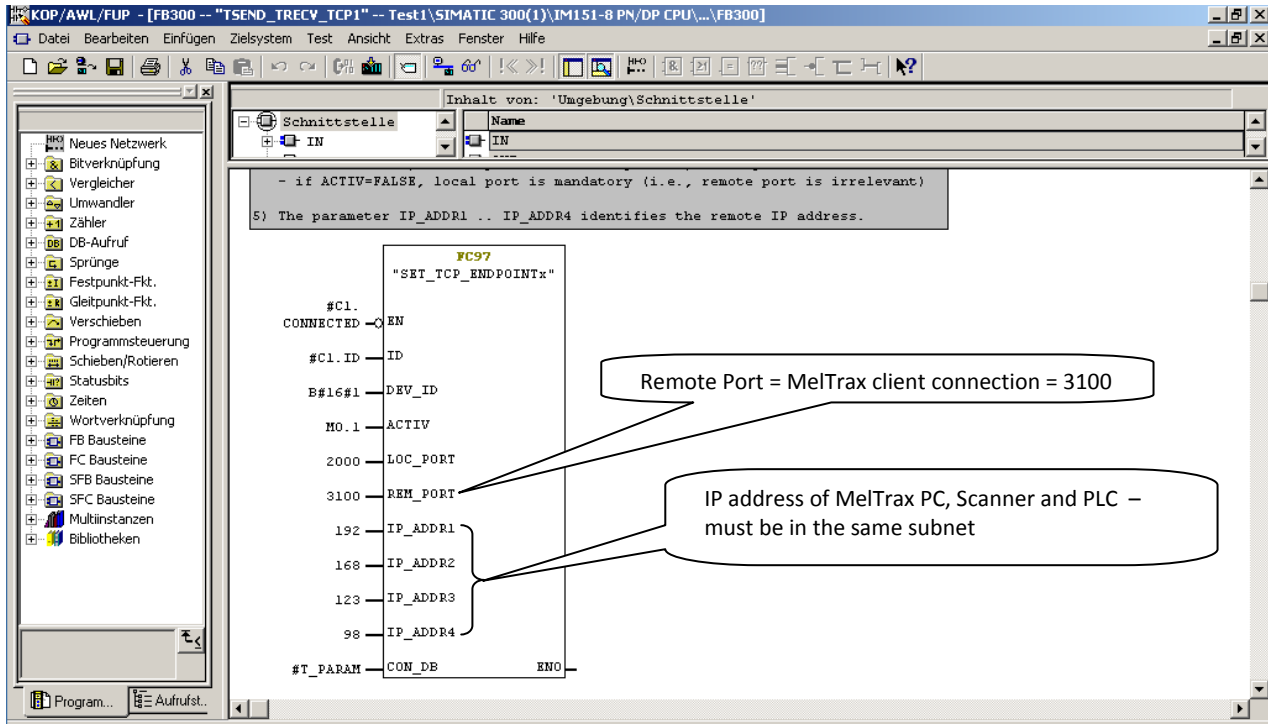

In the function module FC 97 we must set up the IP address of the Computer on which MelTrax is running. In our case it is 192.168.123.98

The **Rem_Port** for MelTrax is 3100 (which is the standard port for Client-to-MelTrax connections). The IP address of the PLC is 192.168.123.224 and the Scanners IP address is 192.168.123.245 – so all 3 partners are in the same subnet.

Important: you must check if your hardware has the same or different **DEVICE ID**. DEV_ID is corresponding to the type of PLC in use, it is our S7-200. Your DEV_ID will be for S7-315 or so...

Timing

Marker byte 10 is responsible for timing. In our example it was set to 1 sec at the beginning. This marker value must be modified to your needs. In our example the timing of 1 sec is ideal to watch the command incoming on the MelTrax software interface panel, each second the light for the corresponding command type is lit for a short while.

First create the hardware configuration for the S7-300 station. Note that you **configure marker byte 10 as clock marker**. The send request is triggered by this clock marker. Save and compile the hardware configuration of your S7-300 station and load it into the CPU.

use FB 300 – network 8 to localise the marker and its setting

set value of byte 10 according table below

The required byte number and value depends from type of the CPU!

Send request cycle time	Marker Byte 10 setting	Time
	10.7	2 sec
	10.6	1.6 sec
	10.5	1 sec
	10.4	0.8 sec
	10.3	0.5 sec
	10.2	0.4 sec
	10.1	0.2 sec
	10.0	0.1 sec

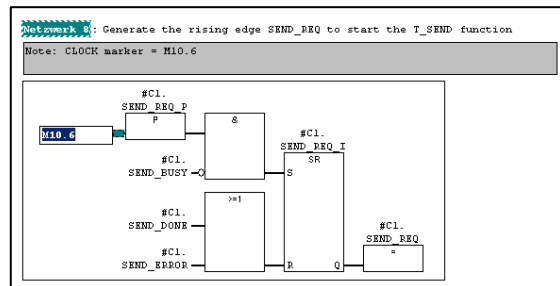
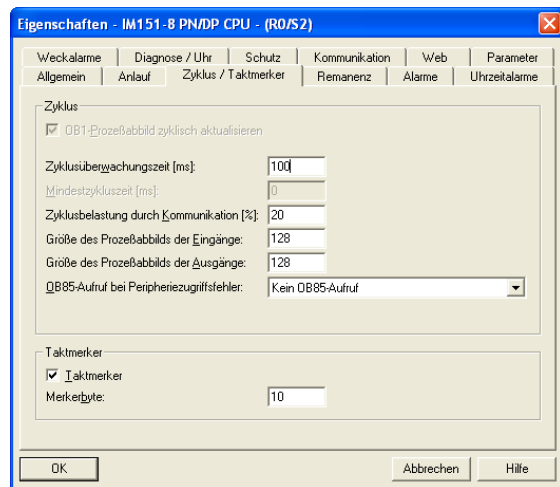

String format of commands (send to MelTrax)

See also table in appendix; example GVACr (Cr = carriage return ; hex 0x0D)

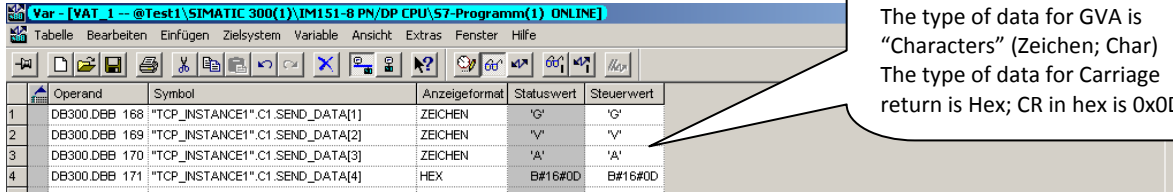

Sending the command GVACr
 The type of data for GVA is "Characters" (Zeichen; Char)
 The type of data for Carriage return is Hex; CR in hex is 0x0D or

In the VAT 1 (Variables Table) data in and out is represented.

The *upper* section is sending from the PLC

The *lower* part is the receive data from MelTrax, pictured below in some examples

Return messages from MelTrax (status and result going to PLC)

Message telegram structure (example – length of data can be different – see table in appendix)		
Header : 2 Bytes	Length: 2 Bytes	Data: 12 or 13 Bytes, depending from length Bytes
FF FE	18 00	Distance + Status (GVCCr)
FF FE	0C 00	Firmware Version 4.5.1 (GL27Cr)
FF FE	0D 00	Serial number (GL23Cr)
FF FE	0F 00	Tracking point Z (GV01Cr)
FF FE	09 00	Temperature (GL22Cr)

Length is calculated including the Cr at end and including the length bytes!

Example: data is +000.00 = 7 Bytes (characters) → length is 7 + 3 + 2 = 12 Bytes = 0x0C (*)

First is header: 2 Bytes = FF FE

Then length: 2 bytes = 0C 00

Then command repeating = L27> when the requested parameter is active, there will be an "A" after the repeating
 And before the > character. The > is the terminator for the complete repeating "string".

Then sign and data and points and data

And last but not least: the terminator for the complete string part = "Cr" (0x0D hex).

When it appears twice as shown in the screenshot below, the client should ignore the second one.

Command GL27Cr call Firmware version

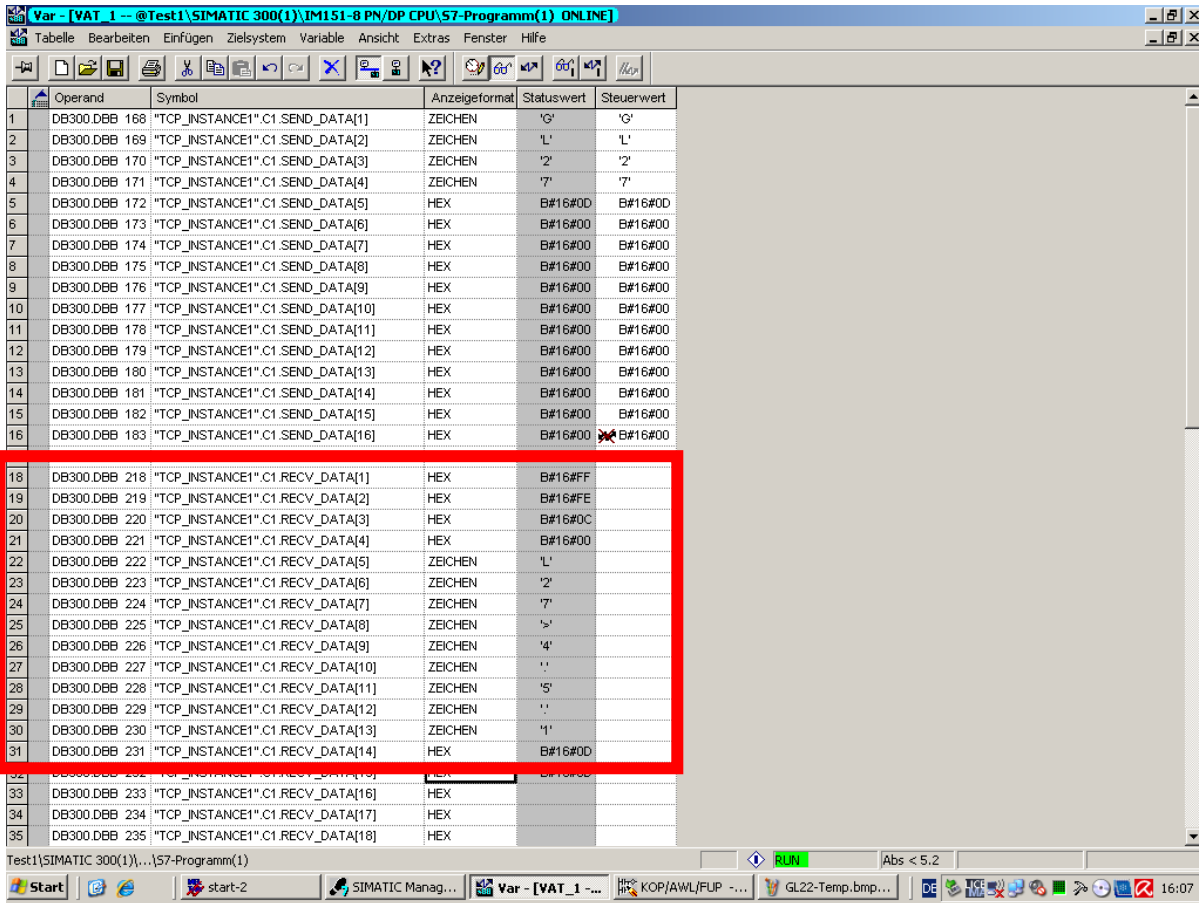

- Reading starts in the line 18 = Header
- In line 20 we have the length
- In line 22 we have the command repeating started
- In line 26 we have the first digit of the firmware number
- In line 27 we have a point
- in line 31 we have the final Carriage return.

a hint from the author: the meaning of the S7 project was to create a simple method to transmit and receive data over TCP Ethernet directly from MelTrax software, to read out results, parameters, status and send commands. The S7 project makes but only the pure logic network data transmission layer. The PLC software engineer must now write and implement additional software modules for parsing and decoding the relevant characters from the strings and take over data into his PLC software environment. MEL can not develop or support such PLC software. Firstly, these software modules are highly specific to the customers machine and secondly due to a significant shortage in man power.

For decoding, the received strings must be stripped off the control characters and compared to a table. The raw information for the compare table is given in the syntax description tables on the previous pages.

In the same way you can call all the commands in the table. More examples to follow... It is important, that you set up MelTrax software to have a good object in range, and tracking point centered; software tracking calibrated with "Center-to-Setpoint" - before you call back any parameters. This will then give parameter values you can understand instead of crunched numbers...

Example: Parameter request using GVC

Operand	Symbol	Anzeigeformat	Statuswert	Steuwert
DB300.DBB 218	"TCP_INSTANCE1".C1.RECV_DATA[1]	HEX	B#16#FF	
DB300.DBB 219	"TCP_INSTANCE1".C1.RECV_DATA[2]	HEX	B#16#FE	
DB300.DBB 220	"TCP_INSTANCE1".C1.RECV_DATA[3]	HEX	B#16#25	
DB300.DBB 221	"TCP_INSTANCE1".C1.RECV_DATA[4]	ZEICHEN	B#16#00	
DB300.DBB 222	"TCP_INSTANCE1".C1.RECV_DATA[5]	ZEICHEN	'\'	
DB300.DBB 223	"TCP_INSTANCE1".C1.RECV_DATA[6]	ZEICHEN	'0'	
DB300.DBB 224	"TCP_INSTANCE1".C1.RECV_DATA[7]	ZEICHEN	'3'	
DB300.DBB 225	"TCP_INSTANCE1".C1.RECV_DATA[8]	ZEICHEN	'1'	
DB300.DBB 226	"TCP_INSTANCE1".C1.RECV_DATA[9]	ZEICHEN	's'	
DB300.DBB 227	"TCP_INSTANCE1".C1.RECV_DATA[10]	ZEICHEN	'.'	
DB300.DBB 228	"TCP_INSTANCE1".C1.RECV_DATA[11]	ZEICHEN	'0'	
DB300.DBB 229	"TCP_INSTANCE1".C1.RECV_DATA[12]	ZEICHEN	'0'	
DB300.DBB 230	"TCP_INSTANCE1".C1.RECV_DATA[13]	ZEICHEN	'0'	
DB300.DBB 231	"TCP_INSTANCE1".C1.RECV_DATA[14]	ZEICHEN	'.'	
DB300.DBB 232	"TCP_INSTANCE1".C1.RECV_DATA[15]	ZEICHEN	'1'	
DB300.DBB 233	"TCP_INSTANCE1".C1.RECV_DATA[16]	ZEICHEN	'1'	
DB300.DBB 234	"TCP_INSTANCE1".C1.RECV_DATA[17]	HEX	B#16#0D	
DB300.DBB 235	"TCP_INSTANCE1".C1.RECV_DATA[18]	ZEICHEN	'\'	
DB300.DBB 236	"TCP_INSTANCE1".C1.RECV_DATA[19]	ZEICHEN	'0'	
DB300.DBB 237	"TCP_INSTANCE1".C1.RECV_DATA[20]	ZEICHEN	'4'	
DB300.DBB 238	"TCP_INSTANCE1".C1.RECV_DATA[21]	ZEICHEN	'1'	
DB300.DBB 239	"TCP_INSTANCE1".C1.RECV_DATA[22]	ZEICHEN	's'	
DB300.DBB 240	"TCP_INSTANCE1".C1.RECV_DATA[23]	ZEICHEN	'4'	
DB300.DBB 241	"TCP_INSTANCE1".C1.RECV_DATA[24]	ZEICHEN	'0'	
DB300.DBB 242	"TCP_INSTANCE1".C1.RECV_DATA[25]	ZEICHEN	'0'	
DB300.DBB 243	"TCP_INSTANCE1".C1.RECV_DATA[26]	ZEICHEN	'0'	
DB300.DBB 244	"TCP_INSTANCE1".C1.RECV_DATA[27]	ZEICHEN	'.'	
DB300.DBB 245	"TCP_INSTANCE1".C1.RECV_DATA[28]	ZEICHEN	'3'	
DB300.DBB 246	"TCP_INSTANCE1".C1.RECV_DATA[29]	ZEICHEN	'2'	
DB300.DBB 247	"TCP_INSTANCE1".C1.RECV_DATA[30]	HEX	B#16#0D	
DB300.DBB 248	"TCP_INSTANCE1".C1.RECV_DATA[31]	ZEICHEN	'c'	
DB300.DBB 249	"TCP_INSTANCE1".C1.RECV_DATA[32]	ZEICHEN	'1'	
DB300.DBB 250	"TCP_INSTANCE1".C1.RECV_DATA[33]	ZEICHEN	'1'	
DB300.DBB 251	"TCP_INSTANCE1".C1.RECV_DATA[34]	ZEICHEN	's'	
DB300.DBB 252	"TCP_INSTANCE1".C1.RECV_DATA[35]	ZEICHEN	'1'	
DB300.DBB 253	"TCP_INSTANCE1".C1.RECV_DATA[36]	ZEICHEN	'M'	
DB300.DBB 254	"TCP_INSTANCE1".C1.RECV_DATA[37]	ZEICHEN	'0'	
DB300.DBB 255	"TCP_INSTANCE1".C1.RECV_DATA[38]	ZEICHEN	'1'	
DB300.DBB 256	"TCP_INSTANCE1".C1.RECV_DATA[39]	HEX	B#16#0D	

When using GVC it might happen that you request a parameter, which is not in use by the algorithm currently active; this parameter is said to be inactive.

Those parameters are marked instead of an "A" with a "I" (upper case i).

The example at the left side shows the result.

The parameters can be recognised by their "number". V03 = R-Distance.

The active algorithm does not use the R-Distance, so the parameter is marked inactive; but the value (if existing) is transferred to the requesting client. The same applies to z-Difference.

The table below shows the "custom parameters" and their "number". ...V03... means parameter R-Distance.

Par. Nr.	Parameter	Meaning
0	Center	X-Coordinate Tracking Point
1	Distance	Z-Coordinate Tracking Point
2	L-Distance	Left height
3	R-Distance	Right height
4	Z-Difference	Height difference
5	Width	Seam / gap width
6	Slope	Tilt angle
7	L-Angle	Left angle
8	R-Angle	Right angle
9	X-Angle	Angle above the profile
10	Seam Height	Seam height
11	L-Groove	Groove depth left
12	R-Groove	Groove depth right
13	Encoder	Encoder position
14	Status	Status

After the parameters the status is sent: C1151M01Cr

Reading from the end: M01 -> Measurement program 01= highest point (Seam Inspection)

C 01151 =>1151->„translated“ in to binary = 100 0111 1111

Bit no	15	14	13	12	11	10	9	8	7	6	5	4	3	2	1	0
value	-	-	-	-	-	1	0	0	0	1	1	1	1	1	1	1

This is:

- Bit 0 (1) -> Scanner OK set
- Bit 1 (2) -> Scanner connected set
- Bit 2 (4) -> Profile set
- Bit 3 (8) -> Recognition OK set
- Bit 4 (16) -> Intensity > 25% set
- Bit 5 (32) -> Intensity > 50% set
- Bit 6 (64) -> Intensity > 75% set
- Bit 7 (128) -> Heartbeat not set
- Bit 8 (256) -> Position too right not set
- Bit 9 (512) -> Position OK not set
- Bit 10 (1024) -> Position too left set
- Bit 11 (2048) -> FIFO overload set
- Bit 12 (4096) -> Record
- Bit 13 (8192) -> Buffer erased (only with Enable_16bit_Status=1)
- Bit 14(16384) -> Position center (only with Enable_16bit_Status=1)
- Bit 15(32768) -> reserved (only with Enable_16bit_Status=1)

What we can see from above decode:

- our Scanner works well
- the Scanner is connected
- the Scanner profile is ok
- the Scanner Recognition is ok
- the Scanner reading intensity is > 75%
- but the Scanner is shifted to the left outside of hysteresis (tolerance) to the side.

Example: GVC (Distance + Status)

Operand	Symbol	Anzeigeformat	Statuswert	Steuwert
17				
18	DB300.DBB 218	"TCP_INSTANCE1".C1.RECV_DATA[1]	HEX	B#16#FF
19	DB300.DBB 219	"TCP_INSTANCE1".C1.RECV_DATA[2]	HEX	B#16#FE
20	DB300.DBB 220	"TCP_INSTANCE1".C1.RECV_DATA[3]	HEX	B#16#F8
21	DB300.DBB 221	"TCP_INSTANCE1".C1.RECV_DATA[4]	HEX	B#16#00
22	DB300.DBB 222	"TCP_INSTANCE1".C1.RECV_DATA[5]	ZEICHEN	'\r'
23	DB300.DBB 223	"TCP_INSTANCE1".C1.RECV_DATA[6]	ZEICHEN	'0'
24	DB300.DBB 224	"TCP_INSTANCE1".C1.RECV_DATA[7]	ZEICHEN	'1'
25	DB300.DBB 225	"TCP_INSTANCE1".C1.RECV_DATA[8]	ZEICHEN	'A'
26	DB300.DBB 226	"TCP_INSTANCE1".C1.RECV_DATA[9]	ZEICHEN	'S'
27	DB300.DBB 227	"TCP_INSTANCE1".C1.RECV_DATA[10]	ZEICHEN	'\r'
28	DB300.DBB 228	"TCP_INSTANCE1".C1.RECV_DATA[11]	ZEICHEN	'0'
29	DB300.DBB 229	"TCP_INSTANCE1".C1.RECV_DATA[12]	ZEICHEN	'0'
30	DB300.DBB 230	"TCP_INSTANCE1".C1.RECV_DATA[13]	ZEICHEN	'0'
31	DB300.DBB 231	"TCP_INSTANCE1".C1.RECV_DATA[14]	ZEICHEN	'\r'
32	DB300.DBB 232	"TCP_INSTANCE1".C1.RECV_DATA[15]	ZEICHEN	'0'
33	DB300.DBB 233	"TCP_INSTANCE1".C1.RECV_DATA[16]	ZEICHEN	'S'
34	DB300.DBB 234	"TCP_INSTANCE1".C1.RECV_DATA[17]	HEX	B#16#0D
35	DB300.DBB 235	"TCP_INSTANCE1".C1.RECV_DATA[18]	ZEICHEN	'C'
36	DB300.DBB 236	"TCP_INSTANCE1".C1.RECV_DATA[19]	ZEICHEN	'1'
37	DB300.DBB 237	"TCP_INSTANCE1".C1.RECV_DATA[20]	ZEICHEN	'2'
38	DB300.DBB 238	"TCP_INSTANCE1".C1.RECV_DATA[21]	ZEICHEN	'7'
39	DB300.DBB 239	"TCP_INSTANCE1".C1.RECV_DATA[22]	ZEICHEN	'9'
40	DB300.DBB 240	"TCP_INSTANCE1".C1.RECV_DATA[23]	ZEICHEN	'M'
41	DB300.DBB 241	"TCP_INSTANCE1".C1.RECV_DATA[24]	ZEICHEN	'0'
42	DB300.DBB 242	"TCP_INSTANCE1".C1.RECV_DATA[25]	ZEICHEN	'3'
43	DB300.DBB 243	"TCP_INSTANCE1".C1.RECV_DATA[26]	HEX	B#16#0D
44	DB300.DBB 244	"TCP_INSTANCE1".C1.RECV_DATA[27]	ZEICHEN	'A'
45	DB300.DBB 245	"TCP_INSTANCE1".C1.RECV_DATA[28]	ZEICHEN	'S'
46	DB300.DBB 246	"TCP_INSTANCE1".C1.RECV_DATA[29]	ZEICHEN	'\r'
47	DB300.DBB 247	"TCP_INSTANCE1".C1.RECV_DATA[30]	ZEICHEN	'0'
48	DB300.DBB 248	"TCP_INSTANCE1".C1.RECV_DATA[31]	ZEICHEN	'0'
49	DB300.DBB 249	"TCP_INSTANCE1".C1.RECV_DATA[32]	ZEICHEN	

Parameter V01 = Z-Trackingpunkt = 0.05 mm

„A“: Parameter = active

Status C1279M03

M03 = Algorithmus 3 = SeamTracking
C1279 => 100 1111 1111

The underlined 1 marks the Heartbeat.

Again, the profile and the recognition is perfect, but the profile is shifted to the left side.

How to decode - example

Read length Bytes = 09 00 = 9 Bytes length in total
Subtract Send string repeat: L22> (4 characters)
Ending = Cr = 1 character

Information length = length value -2 bytes (length)
–send string repeat (4) – Ending Cr (1)

Information length => 9 – 2 – 4 – 1 = 2 characters =
Temperature 34 this is 34°C

What happens when you set the “format” of the read interface wrong?

Example

29	DB300.DBB 229	"TCP_INSTANCE1".C1.RECV_DATA[12]	ZEICHEN	'0'
30	DB300.DBB 230	"TCP_INSTANCE1".C1.RECV_DATA[13]	ZEICHEN	'S'
31	DB300.DBB 231	"TCP_INSTANCE1".C1.RECV_DATA[14]	ZEICHEN	'\r'
32	DB300.DBB 232	"TCP_INSTANCE1".C1.RECV_DATA[15]	ZEICHEN	'0'
33	DB300.DBB 233	"TCP_INSTANCE1".C1.RECV_DATA[16]	ZEICHEN	'0'
34	DB300.DBB 234	"TCP_INSTANCE1".C1.RECV_DATA[17]	ZEICHEN	'\r'

Turn this into a hex value and you see...

... and you see that it is a 0x0D → Carriage return

29	DB300.DBB 229	"TCP_INSTANCE1".C1.RECV_DATA[12]	ZEICHEN	'0'
30	DB300.DBB 230	"TCP_INSTANCE1".C1.RECV_DATA[13]	ZEICHEN	'S'
31	DB300.DBB 231	"TCP_INSTANCE1".C1.RECV_DATA[14]	ZEICHEN	'\r'
32	DB300.DBB 232	"TCP_INSTANCE1".C1.RECV_DATA[15]	ZEICHEN	'0'
33	DB300.DBB 233	"TCP_INSTANCE1".C1.RECV_DATA[16]	ZEICHEN	'0'
34	DB300.DBB 234	"TCP_INSTANCE1".C1.RECV_DATA[17]	HEX	B#16#0D

Proposed method:

Parse the header and the length information.
From length bytes we get the position of carriage return.
Then cut out the relevant data and parse it. ... Done!

Header : FF FE

Length : 2 Bytes

Send string repeat : 3 or 4 characters, terminated by >

Information: 3 ... 8 characters, terminated by Cr

Reading procedure can be done in the following way:
Read length to know the total length of string segment to parsed
Read send string repeat to find out length of send string
Decode send string to know which parameter you received
Read information characters to retrieve data

When you decode send string repetition you can use a table to have the predefined format. Be careful, parameters could be active – then the send string repeat has an ‘A’ or not active, then there is no ‘A’ but an ‘I’. All commands and parameters are case sensitive!



more literature about CPU Identifier and related data transmission you can find from Siemens website:

„How do you program the communication blocks FB67 “TUSEND”, FB68 “TURCV”, FB65 “TCON” and FB66 “TDISCON” in order to use the UDP protocol for data exchange via the integrated Industrial Ethernet interface of a CPU? “

This is available under the following link. This publication is under the copyright of Siemens AG, and we are not allowed to publish data other than a link to the page.

<http://support.automation.siemens.com/WW/llisapi.dll?aktprim=0&lang=en&referer=%2fWW%2f&func=cslib.csinfo&siteid=cseus&extranet=standard&viewreg=WW&nodeid=33810599&objaction=csoopen>



Source code of the S7 test project can be disclosed only after confirmation of the MEL sales coordinator.
Using this source code will be on the sole risk of customer.

Drivers

MelTrax Software does not need drivers with exception of *VScanner and Profibus client*. They need Giveio.sys kernel mode device driver which is to be found in the *Util* folder. The GSD description file for the iControl and the installation procedure help file is in the Util folder, and it is available as well for download on the MEL FTP Server or sent by e-mail on request from MEL.

Registration and unlocking

The software sends out measurement data only, when the registration and unlocking procedure with MEL has been made complete. For registration, you may need a unlock key which is sent from MEL *on request*. The procedure is given below.

When not registered (not licensed) the headline of MelTrax software will show "Evaluation copy". When the software has been licensed, the register tab will disappear and the MelTrax software headline will display the name of the registered customer's name instead of Evaluation copy.

How to register:

1. Click the register Tab
2. Enter your Company name in the **edit box Company**
3. Click the **request** button on the register tab.
4. Copy the request string from the Request Key box
5. Send the request key to: r.kutzner@melsensor.de
6. Add your contracting information and reference
7. Wait for the unlock key
8. Insert the unlock key into the unlock key edit box
9. Click the unlock button

In the TCP Client you can do registration from a remote PC. There is no difference if you do registering / unlocking directly in MelTrax or in the TCP Client. Following an example for registering with TCP client:

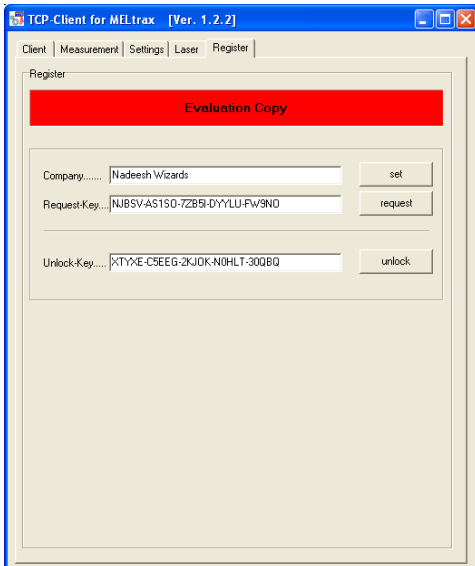

- Click on the tab „Register“
- Enter the name in the edit box „Company...“
- click „request“
- a string of characters appears

☞ copy these characters into your e-mail program and Send it with e-mail to: mail@melsensor.de or give the combination of numbers and letters on the phone or over MSN Live Chat or Skype.

The code is case sensitive, Zero and O are different, Zero [0] is lean, the O is fat.

MEL will give you an unlocking string
Enter the Unlocking key in the edit box
Then click the „unlock“ button.

The „Register“ tab disappears in the MelTrax Software and your MelTrax software is licensed. Clients do not need a license.

In the TCP Client the tab *Register* does not disappear, but the status bar in the upper part of the tab turn green with the statement "Register OK"

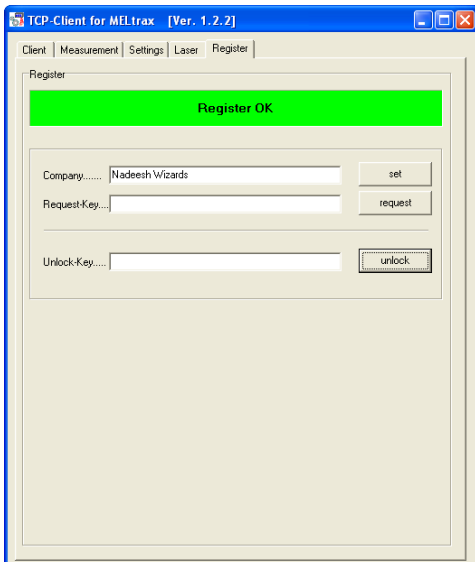

! in the TCP Client never change the register tab, *this* could cancel your license.

☞ When you launch the MelTrax application on another PC, MelTrax will start up as "Evaluation copy". You will need a new *unlock string* for this PC.

It is not a good idea to change the name entry in the Company name edit box. This will cause the license to vanish and you will need to go through registration procedure again.

Registration of your MelTrax Software is locking to the Hardware of your PC. When you want to run MelTrax on another PC, you will need a new licensing code. Contact MEL, when you want to do this in advance.

VScanner

Virtual Scanner has been created for MEL iControl. From there, scan data is sent over the network to MelTrax software. MelTrax can be installed on the same PC or on any other PC in the network. With VScanner, MelTrax software receives data as if this data would have been sent from an M2-iLAN Scanner in the network.

The sending port is 3000 (default), the packet structure and data contents is exactly the same as for other Ethernet Scanner models. The advantage is, that any other software capable to read a M2-LAN Scanner can use this data provided by the VScanner.

Launch VScanner

MelTrax.exe should be started before VScanner.exe is started. When the communication is established, VScanner displays the status and the number of clients connected to MelTrax software. The number of clients is not limited.

When the client starts to establish communication, the status bar displays for a few seconds "Waiting for connect" in yellow. When a network problem occurs the status bar will turn red and display error 10061.

The radio buttons in the source group selects the source of data which is transmitted to the MelTrax software. When file is selected, VScanner plays the file. The checkbox "loop" allows repeating the file playback over and over again. Test is an integrated test data file. The radio button "Scanner" makes VScanner receive data from a scanner.

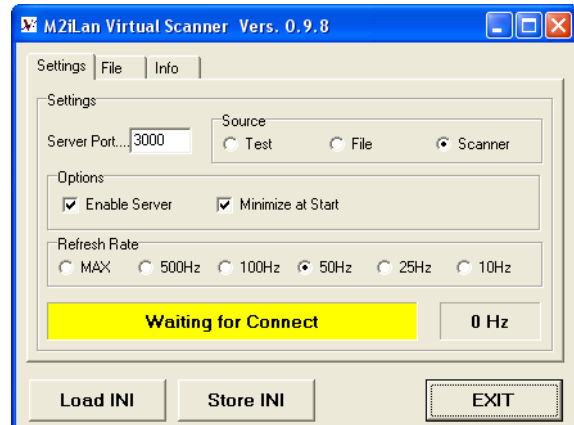
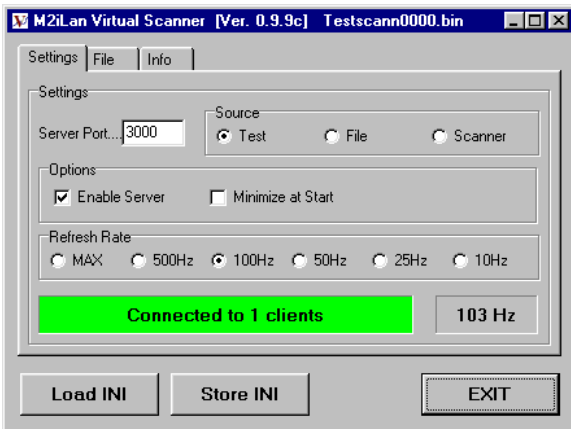
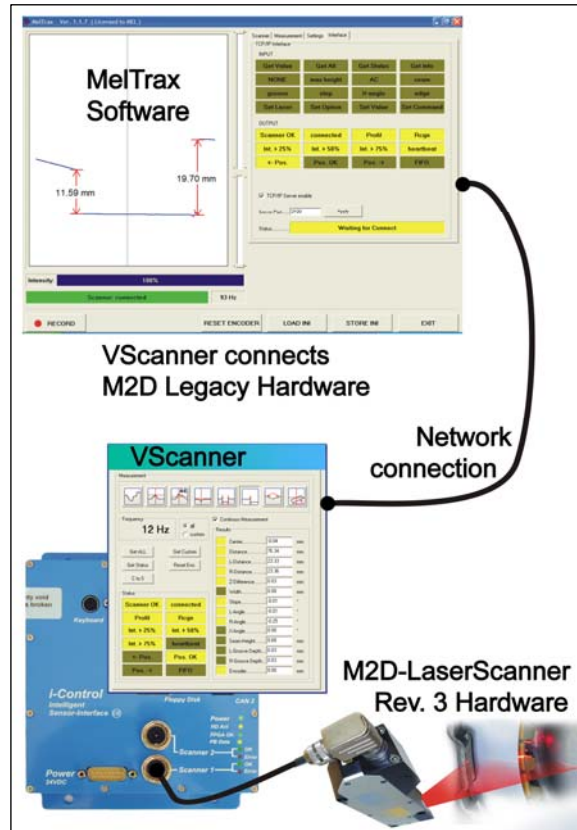

File Player

VScanner has a built in file player. The play feature can play out scan data files from Scan Recorder or MelTrax. Set File selects the field dialogue for selection of the data file.

The green arrow starts play back. Back-, square- and forward buttons work like a cassette recorder. When the player is paused, the slider acts for scrubbing through the file.

Loop function repeats selected recordings. When the option *auto next* is selected, the player automatically selects the next file in the chosen folder, when the file play out is terminated.

What VScanner can do:

- file player
- play out test signal
- connect legacy M2D Scanner to MelTrax



VScanner may be helpful for diagnosis: record files with MelTrax and play it back for closer review.

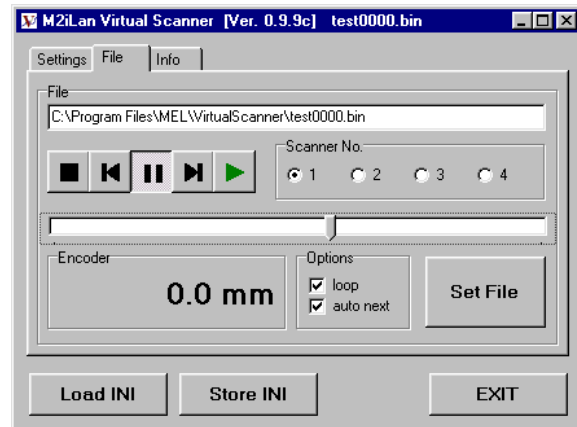

Info

The Info screen displays info about the scanner, serial number, temperature of the scanner head, range, and more. With Rev. 2 hardware (< 2003), the read out does not work.

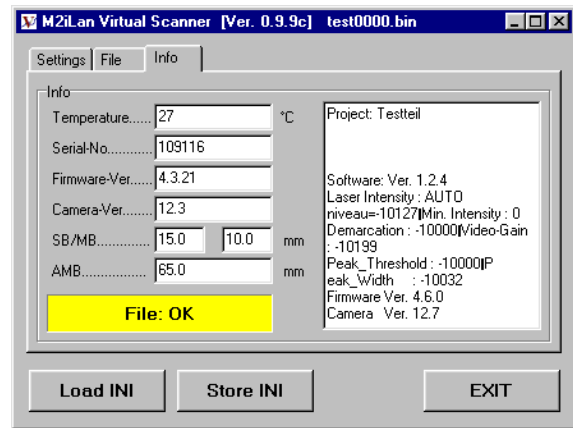

Driver

VScanner requires *giveio.sys* kernel mode device for operation under Windows XP. Details for installation of *giveio.sys* driver are given in the *giveio.sys* installation guideline and in the help file in the directory.

Connection Status

When MelTrax is connected to VScanner, the status bar in MelTrax shows Scanner: connected. The scan profile should then be visible. The FiFo display should remain empty or very low in best case.

When the connection between VScanner and MelTrax has been established, other clients may connect to the MelTrax for remote control and data transfer, like Profibus client, display client or TCP client.

The clients may be active somewhere in the network or on the same PC.

The screenshot on the lower right side shows english client connected to MelTrax. Algorithm No.1, maximum peak is selected.

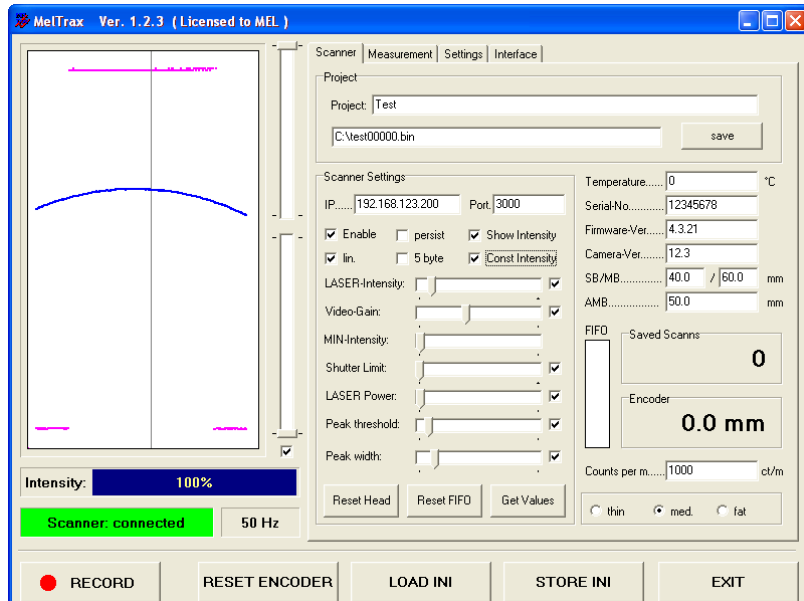

Network settings

Example:

iControl 192.168.123.200
 PC 192.168.123.129
 Port VScanner: 3000
 Port ProfiBus Client: 3100

IP Address may be set according to the network properties. Scanner and MelTrax must be in the same subnet; this means only the last 3 digits of the IP address may vary.

The following IP addresses must not be used:
 xxx.xxx.xxx.0 and xxx.xxx.xxx.255

Please note: IP addresses must not be used twice. DHCP is not supported; therefore defined IP addresses are required. A gateway is not required; MelTrax and clients make a peer to peer connection.

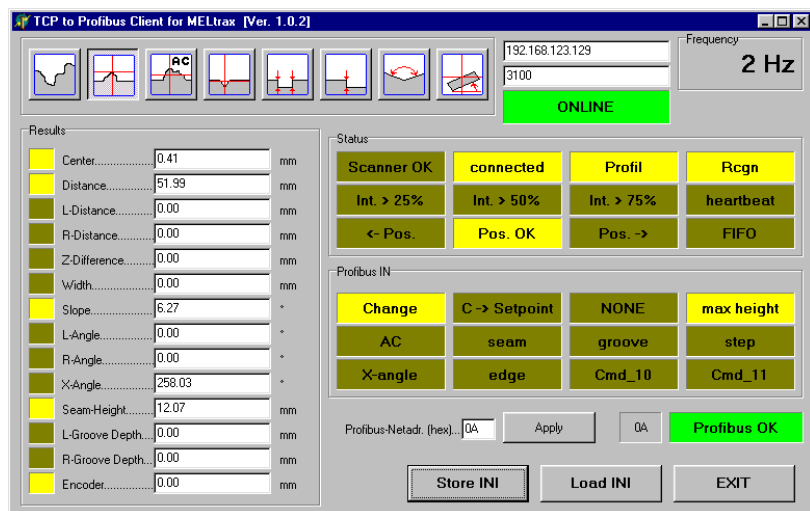

Localhost

localhost is the name for internal network connections, which are made by the operating system and the network components working in your PC. This connection will be available in a PC when network is set up and active. There is no need for any configuration or set up procedure; localhost is “already there”, it is included in basic network operation. MelTrax and the MelTrax-Clients use this connection for data exchange, when they are active on the same PC. For localhost, TCP standard defines the IP address 127.0.0.1

MEL Software and VScanner

VScanner may be combined with other MEL Software. VScanner acts like a multimedia player, which plays back data previously recorded. VScanner hands over data via TCP/IP to the receiving software. When the software works on the same PC, it is set up to the IP address of localhost 127.0.0.1. When it runs on another PC, the software is set to the IP address of the sending PC; in this case this is the IP address of the PC with VScanner.

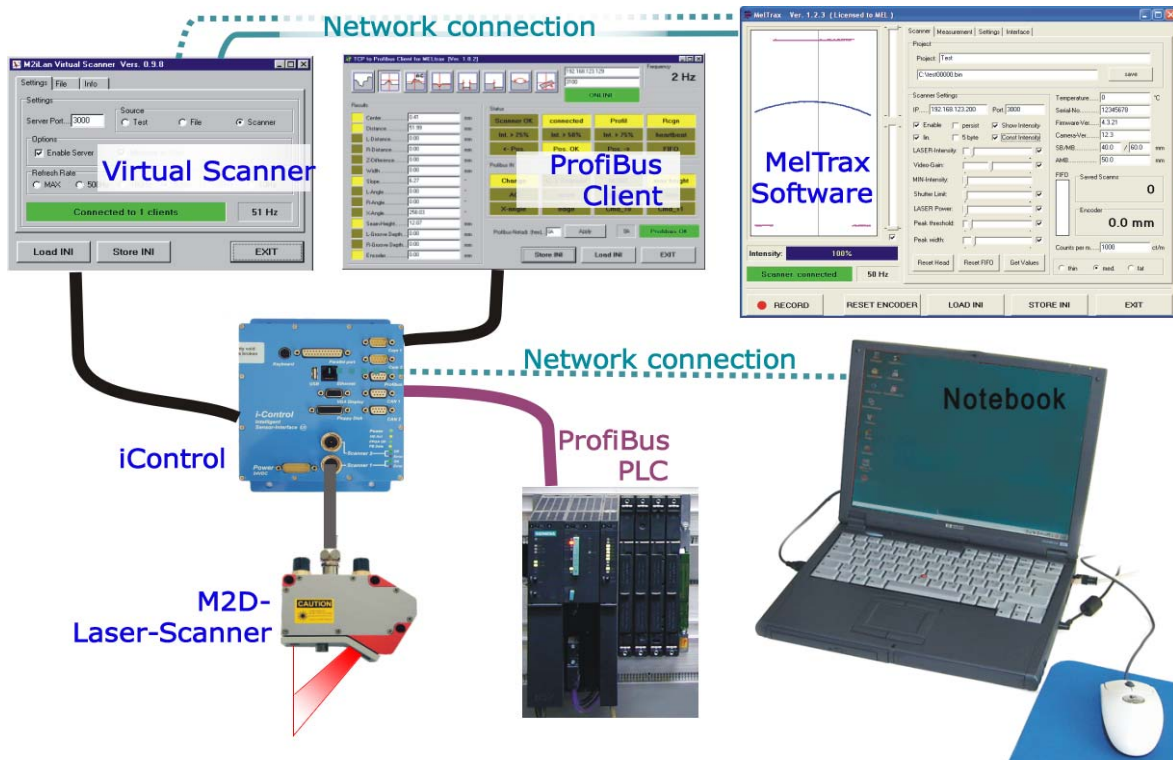

The following software packets could receive „client“ profiles from VScanner:

- EthernetScanRecorder-1.2.8
- EthernetScanner-2009
- WxEth
- iVision-24.7.07
- iVision-2009 (rev. 1.3.0 – 6.11.2009)

These software packages are no MelTrax clients, but they read the data stream from the VScanner and display profile on screen. More details are given in the individual manuals of these software packages.

VScanner and Profibus Client are made for the iControl hardware. You may use VScanner also with older 266 MHz CPUs with a few limitations*.

MelTrax has built in his own “remote controls”, therefore no additional remote control software needs to be installed. This saves CPU performance. When minimizing the main screen at start, this saves also a lot of CPU performance. Low performance mode is a compromise. It does not save as much performance as minimize at start, but it slows down the updating of the screen just a bit, so work is still possible. The CPU performance which has been saved does then to the calculation which will be more effective and using up the remaining CPU performance.

* read out of scanner configuration data does not work from Rev. 3 Hardware (iControl 300 MHz version) read out of scanner configuration data will work.

** there are no graphics drivers for 500 MHz iControl for Windows 98 operating system! Therefore we must use Windows XP operating system for the 500 MHz iControl.

Display Client

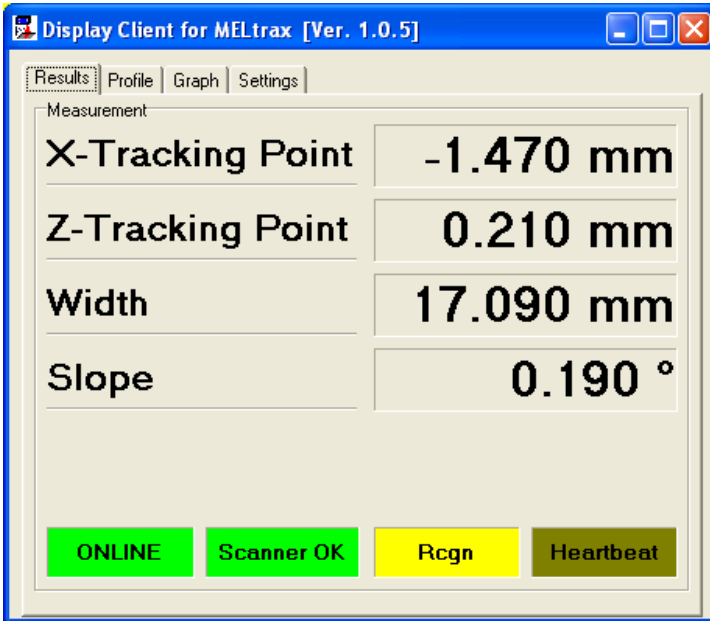

Display Client requests four measurement values from MelTrax Software, which are displayed as big numbers on the main screen. Selection of the measurement values, setting of IP address and port is made on the “Settings” tab of the Display client. Each of the four parameters can be selected and set to individual scaling, so that all signals are clearly visible.

The Display Client can run on the same PC as the MelTrax Software, in this case the connection to MelTrax is made with the localhost, IP-Address 127.0.0.1. When MelTrax and Display Client run on different PCs, in the Display client the IP address of the MelTrax PC is to be set.

In the „Settings“ of the Display Client the “Refresh-Rate” is defined. In our example the refresh rate was set to 50 msec, that means that our measurement values are updated 20 times per second.

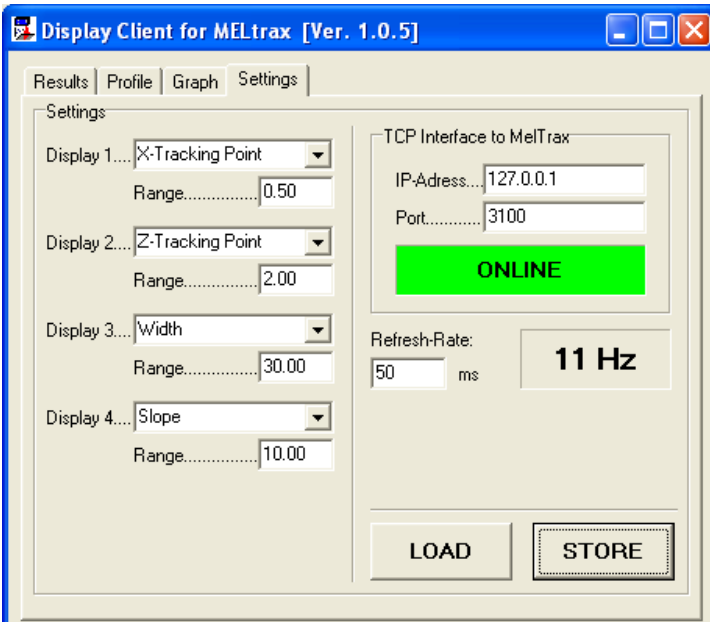

History Graph

Recording the output signals can be used to research automatic positioning in a machine.

In the „Graph“ window, the recorded signals can be zoomed. The zoom window can be shifted in all directions with the right mouse button. At the left side at bottom you find some examples of recorded history graph.

To start recording click the activation checkboxes at the right side for each parameter you want to be “recorded” and click “Enable”. When you deactivate *Enable*, the recording stops.

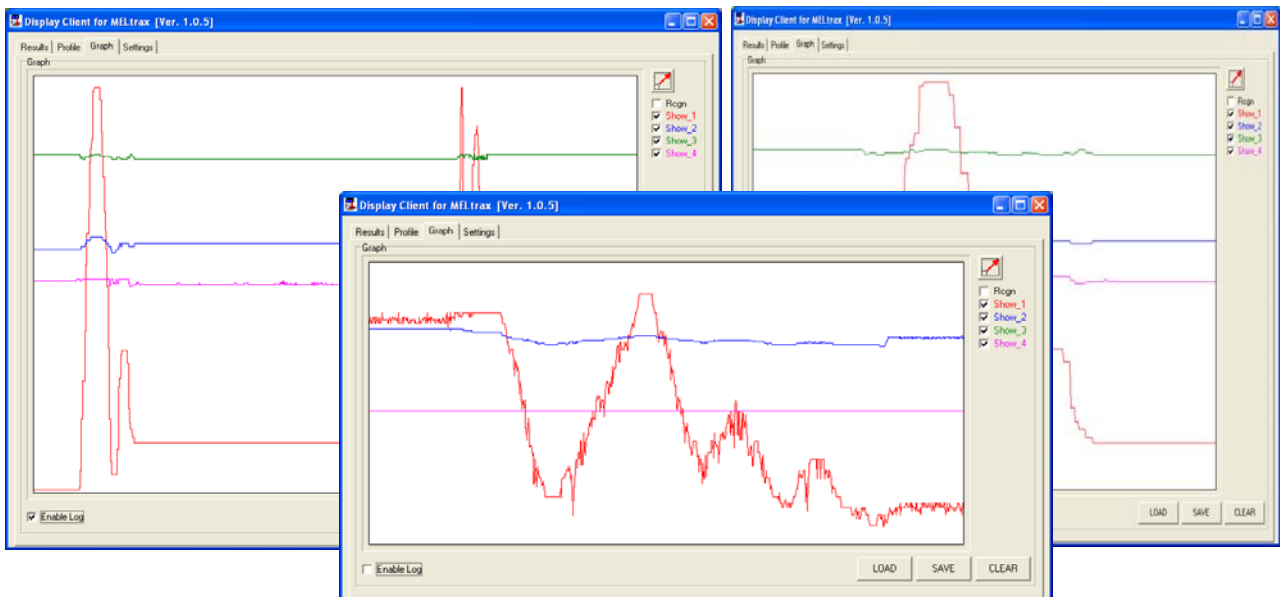

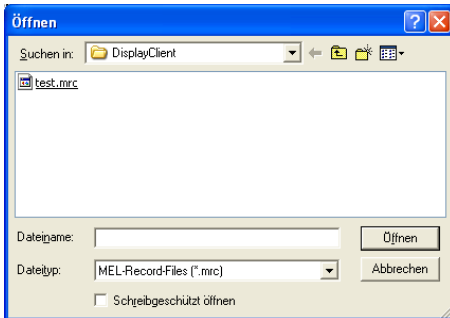
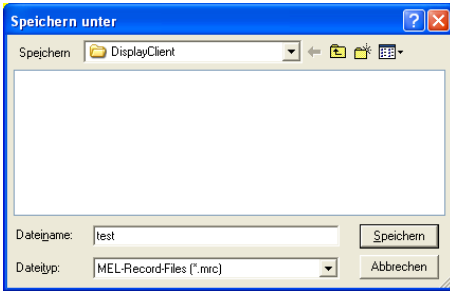

the recorded traces can be saved and recalled later with the buttons „Save“ und „Load“. This allows you to record a trace with a mobile PC and analyse it later at home.



Please note the difference between recorded scan profile data *.scan and the recorded traces *.mrc files. The traces are “measurement results” which have been mathematically treated by an algorithm and the scan profiles are *raw* data.

When you do a recording with the record function, you will receive raw data, which can be played back with the VSscanner. These play back data will appear the same as live data from a M2-iLAN Scanner.

This playback will allow testing different algorithms on the same data record. Of course raw data takes up much more space on disk as traces. For a long term recording it might be better to record traces instead of scan profile data.

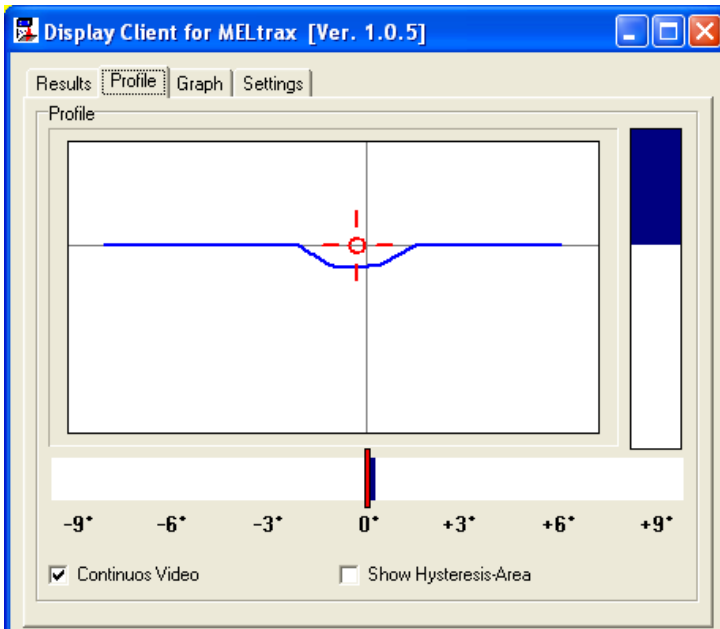

The tab „Profile“ shows the current scan profile. The option “Continuous Video” should be activated for a live view of the profile.

This creates some load for the CPU. For weak PC's this option is not recommended.

The profile window is rather small. Therefore the vertical axis of the profile is zoomed, to allow to see more details. The view is kept more or less centered, so that the profile is always visible: the software shifts the view range over the scanners vertical viewing window. The vertical blue bar at the right side of the profile window shows the position on the z-axis.

The horizontal blue bar shows the tilt angle (slope).

With „Show Hysteresis Area“ the range where the software sends position OK can be shown.

Analog Client

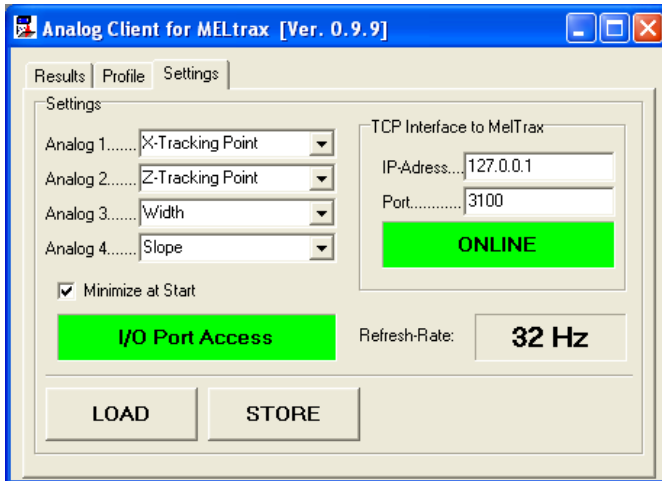

The Analog Client needs the Hardware of the MEL iControl for output of the four signals from MelTrax as analog signals 0 ... 10V.

The analog output signal varies from approximately 0 Volt to approximately +10V. When the cursor is in the center, the output voltage is +5.0 V.

The limits of the output voltage can not be adjusted, but the direction of the signal can be changed with the options Invert-X and Invert-Z in the MelTrax settings page. The output voltage remains in the range of 0...10V, but the scaling and the tracking point changes.

The analog client can display the scan profile in the same way as the Display client.

The display of results as numbers is coupled with the output of analog signals. The signals selected for analog output are also displayed as numbers on screen.

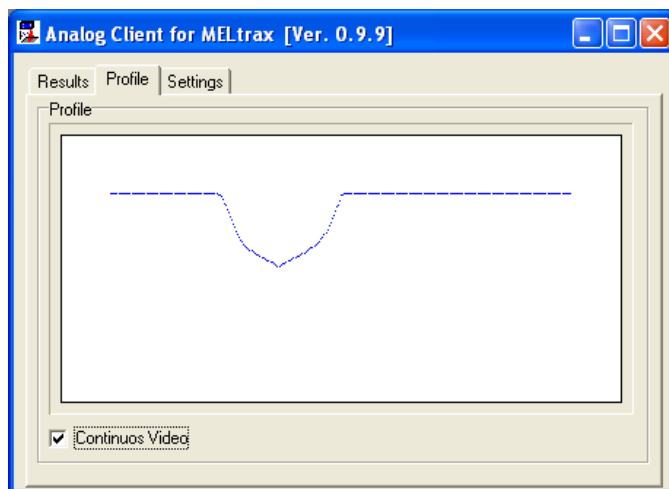

The lower part of the numbers display shows the status of the scanner, connection status, recognition status, position information left / right and the heartbeat.

The connection status must show in green „ONLINE“, error 10061 means no network connection, IP-Address or Port incorrect, or blocked by another instance of another Analog Client. When you try to start the Client a *second time* this is what happens: error 10061.

if you want to show additional signals at the same time you can open a display client or you create folders and launch the analog client from another folder. Only the first client will be able to drive the analog outputs, but the other ones could be used as lean display clients.

create a new folder and *copy* the client-exe file to this folder.

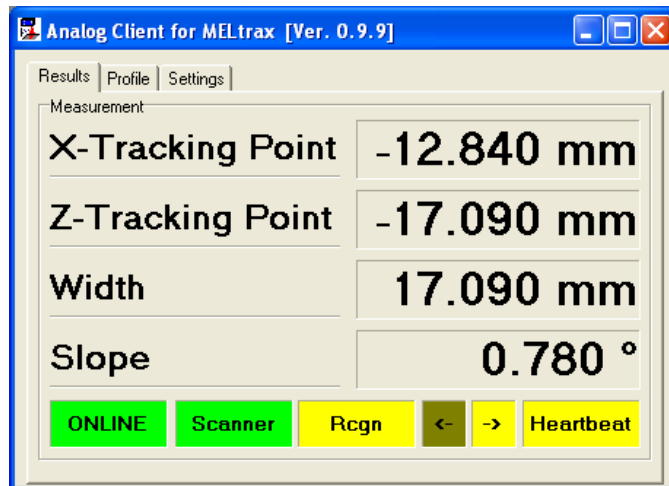

Factory preset is, that the analog client starts and minimizes to the task bar. This makes sense, because the analog client shall “only” deliver the analog outputs of the iControl.

Profibus Client

Profibus Client is a standalone software; an option to MelTrax software. With an iControl MelTrax can be easily connected to Profibus. The Profibus client has been specially designed for iControl. For a PCI Profibus card, a modified Profibus client is available on request.

The Profibus client receives measurement result data and commands over network and transmits it to the Profibus. Commands from the Profibus master are transferred to MelTrax software.

When the Profibus client and MelTrax are active on the same iControl, the Profibus client receives data over *localhost*. The TCP-IP Address of the *localhost* is always 127.0.0.1; the port is adjustable, default = 3100.

Profibus Client and TCP Client must use *different* ports:
Profibus Client port 3100; TCP Client port 3101.

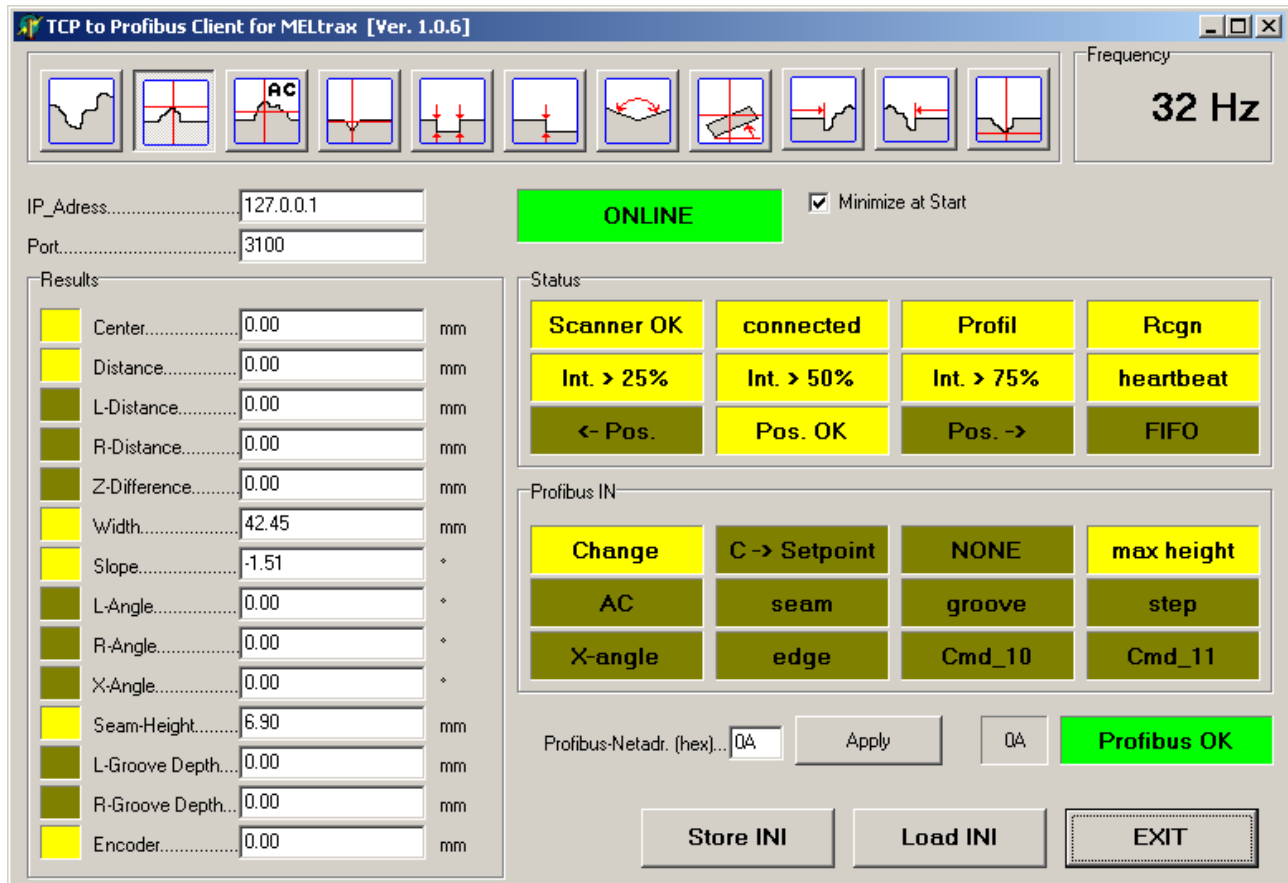

In the Profibus Client the edit box “Profibus-Netadr” defines the Profibus address of the client. When you enter the Profibus address click “Apply” to make it active. The actual Profibus address is shown beneath the Profibus status display. The Profibus status display will show OK (green) or error messages (red) – see table below.

Please note: the iControl Profibus is always *Profibus-DP slave*.

The GSD description file MEL_IC.gsd publishes the properties of the Profibus slave. The GSD is part of delivery of the Profibus client, but also available as download from MEL FTP server (<ftp://melsensor.de>) or on request from MEL.

The Profibus client screen shows the measurement results. Status messages are shown as LED's. The Profibus status should always show “Profibus OK”. When the message „Profibus Error 2” is shown, check cabling and set up configuration. Profibus errors may also occur, when other software is running in background.

Profibus Status	Meaning	Color
Profibus OK	Normal operation	Green
Error 1	Hardware error	red: maintenance / repair
Error 2	No Profibus cable	No Profibus master, cable not connected, wrong PB-address
Error 3	error 1 + 2	Red: maintenance / repair

When MelTrax and Profibus-Client are working on the same iControl:

When the Profibus Client is searching for (a not existing or not connected) Master, the CPU is busy. In this case recognition failures may occur *temporarily*. When the Profibus connection is established, these recognition errors will disappear.

Profibus-Interface

24 byte out			
Byte	Status word		2 byte (UINT)
0 1	Bit 0	Scanner-Error	
	Bit 1	Profile exists	
	Bit 2	recognition ok	
	Bit 3	seam too right	
	Bit 4	seam too left	
	Bit 5	Intensity less then 75%	
	Bit 6	Intensity less then 50%	
	Bit 7	Heartbeat	
	Bit 8	Position too left	
	Bit 9	Position OK	
	Bit 10	Position too right	
	Bit 11	FiFo Alert	
	Bit 12 ... Bit 15	Reserved	
2, 3	Center	1/10 mm	2 byte (INT)
4, 5	Distance	1/10 mm	2 byte (UINT)
6, 7	Width	1/10 mm	2 byte (UINT)
8, 9	L-Distance	1/10 mm	2 byte (UINT)
10, 11	R_Distance	1/10 mm	2 byte (UINT)
12, 13	Z-Difference	1/10 mm	2 byte (UINT)
14,15	Slope	°	2 byte (UINT)
16, 17	L_Angle	°	2 byte (UINT)
18, 19	R_Angle	°	2 byte (UINT)
20, 21	X_Angle	°	2 byte (UINT)
22, 23	Seam_Height	1/10 mm	2 byte (UINT)
24 byte in			
	Command word		2 byte (UINT)
0 1	Bit 0	Change Signal (set value when the change Bit is set)	
	Bit 1	Setpoint = Center	Setpoint to Center
	Bit 2	Meas. Prog. 0	No evaluation
	Bit 3	Meas. Prog. 1	Max Height +Area Centroid (H+AC)
	Bit 4	Meas. Prog. 2	Area Centroid only
	Bit 5	Meas. Prog. 3	Seam Tracking
	Bit 6	Meas. Prog. 4	Groove depth (Groove)
	Bit 7	Meas. Prog. 5	Step
	Bit 8	Meas. Prog. 6	Angle (X-Angle)
	Bit 9	Meas. Prog. 7	Edge
	Bit 10	Meas. Prog. 8	Edge from left
	Bit 11	Meas. Prog. 9	Edge from right
	Bit 12	Meas. Prog. 10	Min height point
Bit 13... Bit 15	Reserved		
2, 3, 4, 5	Setpoint X	1/100 mm	4 byte (UINT)
6, 7, 8, 9	Center Hysteresis	1/100 mm	4 byte (UINT)
10, 11, 12, 13	Min_Height	1/100 mm	4 byte (UINT)
14...23	Reserved		

Example:

Byte 0, Bit 0 = Change Signal: when set the value is taken

Byte 0: value 1 = change value 2 = Setpoint to Center
 value 3 = take Setpoint to Center value 9 = Highest Point + change signal
 = Setpoint (zero of X-axis) in 1/100 of mm
 = Center Hysteresis in 1/100 of mm
 = Min_Height in 1/100 of mm
 Setpoint = 55 value = 5500 in 4 Byte: 124 + 21 hex = 7C + 15
 Hysteresis = 15 value = 1500 in 4 Byte: 220 + 05 hex = DC + 05
 Rcg. Height = 0,8 value = 80 in 4 Byte: 80 + 00 hex = 50 + 00

At first the value of Setpoint and hysteresis is transferred to MelTrax application. The measurement is active. In the first program step the highest point is taken as Setpoint. The cursor jumps to the highest point.

Condition: the profile must provide a highest point in the range of the hysteresis. When no recognition is possible due to mismatch of the profile, the algorithm will not update the result.

Special Profibus Clients

Screenshot example: NG Client for 3 Instances of MelTrax Software

Hardware: Profibus PCI card for PC
 Operating system : Windows XP

Information about custom specific clients are available on request!

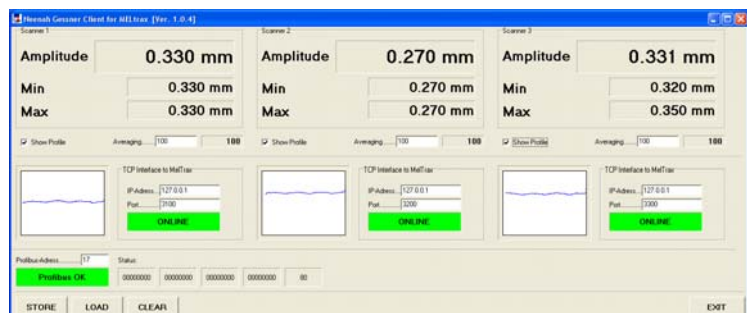

The Tool “Byte.exe”

Byte.exe is a tool which helps to calculate Bytes from a given number. With the check box “*Bit-Order drehen*” the bit order is reversed. This may be helpful for Siemens PLC’s.

The values must then be converted to hexadecimal. This can be done with the Windows Calculator.

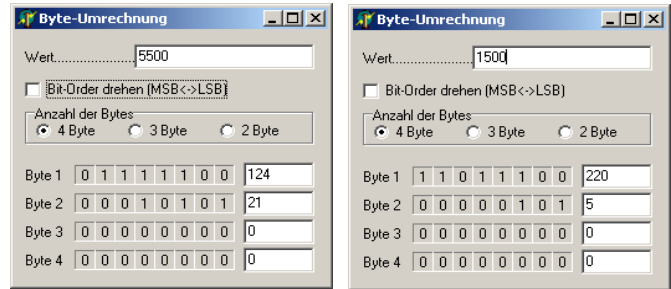

Environmental conditions

Please make sure that the power supply lines are kept far away from welding current source and weld torch cables. The weld current power lines and ground lines shall be close to each other to avoid spreading magnetic fields from the weld current.

Power supplies for the M2-Laser-Scanners shall be potential free and shielded against immissions. Avoid strong magnetic fields in the environment of the Laser-Scanner. Please mount the Scanner cables in a way that the cables do not touch the weld plates.

Check the temperature of the cooling water. The water at the outlet should not exceed 45°C. The water pressure should be 2 ... 4 bar.

Protection from arc and sputter

The scanner head shall be protected against the arc with a metallic plate. This will remove the impact of the strong light and prevent sputter to destroy the protection windows. Replacement windows are available as optional accessories.

Maintenance of the Laser-Scanners

The Laser Scanners is virtually maintenance free. As these are optical systems, they are sensitive to dust and sputter on the front windows. Cleaning is best done with a soft cloth. Do not use scratching cleaners or other aggressive media.

Tipp: remove grease or finger prints with 20 % alcohol + distilled water or benzene also lens cleaner towels, like sold for cleaning eye wear can be used.

Finger prints cause degradations in the scan profile. Remove finger prints before they were burnt in!

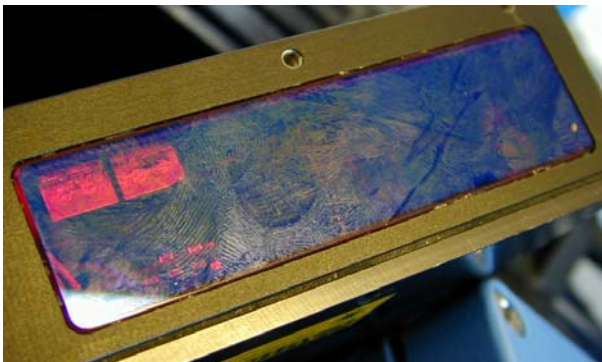

Example: finger prints (after mounting)

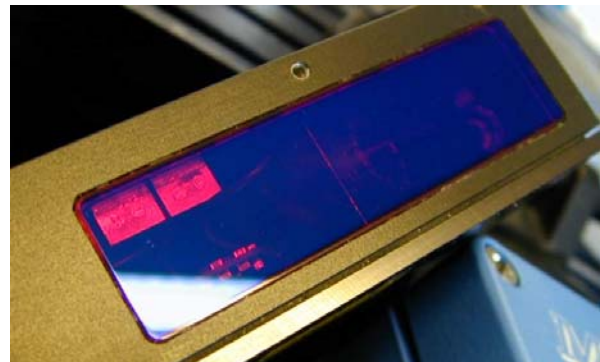

after cleaning with alcohol + soft paper

MelTrax Software Manual

Trouble Shooting

Problem	Cause	Solution	Remarks
no Laser light	no +12 V power	Switch on supply	Cables connected?
	Scanner head not connected	Connect scanner head	
	PC does not start	Check operating system	
	Software does not start	Launch MelTrax.exe	Make short cut in Windows system start up folder
	Laser Intensity too low	Check settings	Set to automatic mode
Recognition error	Front window dirty	Clean front window	Use soft paper + alcohol
	Laser Intensity too low	Check laser settings	Set to automatic mode Check video gain settings
	Object not in range of laser	Move object into range	
	Object extremely mirroring	Check settings	Use filters
	Wrong settings	Check settings	
	Software does not start	Launch MelTrax.exe	Make short cut in start up folder
	Another application is active in background	Terminate the other application	Use anti virus software to detect malware
no function	no power supply	Switch on Power	Is the laser visible?
	Scanner head not connected	Connect scanner head	Is Eth.-Link blinking fast?
	Software does not start	Launch MelTrax.exe	Make short cut in start up folder
	Software freezes	Check Laser „Enable“	Check operating system
		Check network function	Start manually
	Reinstall software	Check internal Hard Disk	

MelTrax Software Manual

Installation

Hardware requirements

PC: CPU min. 1 GHz clock, 1 GB Ram, hard disk, network connection 100 Mbit or MEL iControl with Virtual Scanner and M2D scanner head connected at the iControl

Laser-Scanners: all Laser Scanner of type M2-LAN or M2-iLAN or M2-iL2 *¹

Software requirements

Operating system: Windows XP, Windows 7, Windows Vista, Windows 98, Windows 2000
When MelTrax.exe is active, no other software should be active in background.

„Installation“ of MelTrax Software

MelTrax is available as a Zip-Archive over e-mail, download or on CD or other carrier *². When we send software via e-mail, we rename the *.exe files to *.xyz. When installing, this renaming needs to be corrected back to *.exe. MelTrax needs not to be installed, you need only to unpack and launch MelTrax and the clients.

1. Software components

The folder, in which the MelTrax software is installed can be named as you like it. We propose to install it in a folder C:\Programs\MelTrax.

 the following files should be in the folder MelTrax:

File	Function	Req. Hardware	
Eth_Scanner.ini	Configuration file	Windows PC's and iControl	
Xconfig.ini	Configuration file		
start.exe	MelTrax Software application		
Folder Display_Client	Display_Client.exe Tconfig.ini MEL.ico *.mrc	Graphical visualisation of results Ini file Icon Recorded result (graph) data	Windows PC's and iControl
Folder Profibus_Client	Profibus_Client.exe Tconfig.ini Profibus.txt	Profibus interface Ini file Interface documentation	Only for iControl
Folder Analog_Client	Analog_Client.exe Tconfig.ini MEL.ico	4 analog output signals 0...10V Ini file Icon	Only for iControl
Folder TCP_Client	TCP_Client Tconfig.ini	Maintenance, remote control and result displays Ini file	Windows PC's and iControl
	Rec.bmp Stop.bmp	Icon Icon	
Folder Selection_Client	Selection_Client.exe SC_Config.ini	Quickly switch program configuration sets Ini File	Windows PC's and iControl
Folder Virtual_Scanner	VScanner.exe M2Vconfig.ini Vscan.ico Back.bmp First.bmp Forward.bmp last.bmp Stop.bmp Play.bmp Pause.bmp	Virtual Scanner: „transducer“ for Scanner Rev.3 Hardware at the iControl and File Player for recorded scan data files Ini file Icon Icon Icon Icon Icon Icon Icon Icon	Windows PC's and iControl

MelTrax can operate with all laser scanners of M2D-F/L ...M2-iLAN or M2D-L... the scanner geometry is automatically read in from the scanner head when the software starts.*³

*¹ all models of M2-iLAN, M2-iL2 with integrated electronic system or M2-LAN with blue box electronic system can be used.

*² contact MEL Technical Support for details.

*³ read in of scanner hardware related data may not work with Hardware Rev.1.

MelTrax Software Manual

2. Automatic Program Start

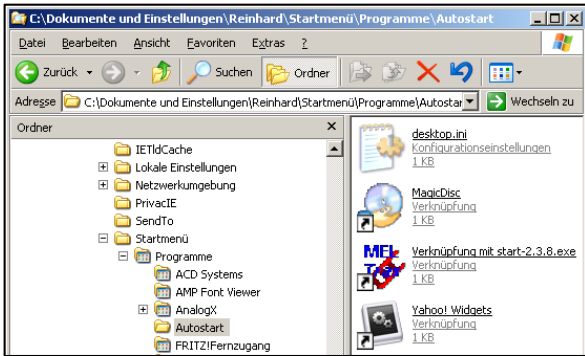

If MelTrax shall start automatically with system start, create a shortcut to start.exe and place it in the start up folder of the operating system: use explorer[all users] and navigate to Start menu / programs / start up [in other languages the names of the folders are different, and we took the screenshots on the left side from a German system...]

For the next steps, it might be helpful, when the hardware (Scanner, network- and power cables) are on site. We think, it is a good idea to set up the scanners and the software in the lab before installing it to the machine. This will allow checking the set up and function of all components.

3. Set up the network

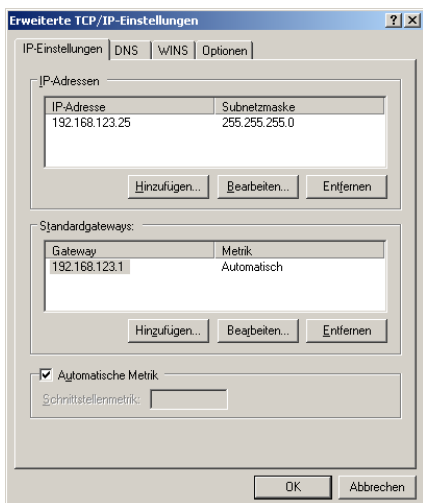
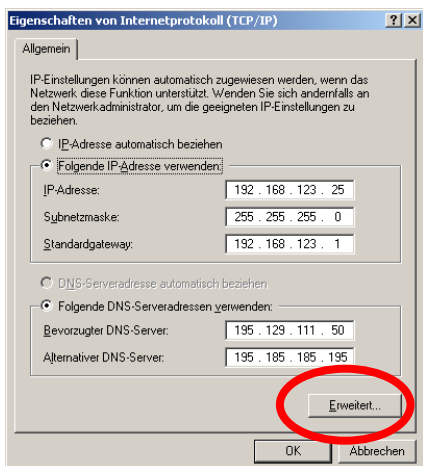
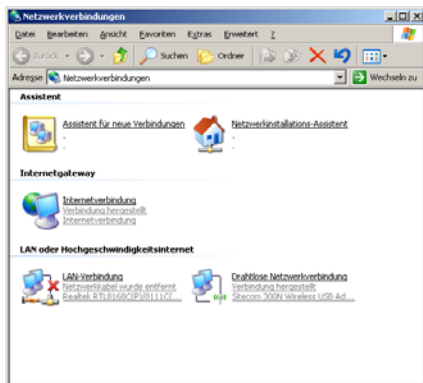

before you can set up MelTrax-Software and the IP-Address of the Scanner and connect the MelTrax Software with your Scanner, you should check the configuration of your network card. At least you need to know how your network card is set up to be able to find any problems. When MEL has delivered a complete system, it should be configured and set up to run. For all other cases, we have documented here some basic facts and a step by step procedure:

- ➡ M2-iLAN Scanner do **not** support **DHCP**. This means, you have to have a defined Firmly set IP-Address in your network card.
- ➡ open „Network environment“. Search for „Status“ and then for Internet protocol TCP/IP4. Click on „Properties“ The screenshot on the left side shows a „working“ configuration.
- ✎ Set up a network address with the pattern similar to: 192.168.123.xxx. Windows pre-sets the subnet mask after a click in the subnet field automatically to 255.255.255.0. Keep this setting.
- ➡ When you are in a company network, and when you have a firm IP address which you should not change, then you can use a secondary IP-address with your network card without conflicts, presumed, that the IT department in your company allows to use this trick. If not, then blame the IT department for a better solution!

The trick, to „open“ a second subnet is given with the procedure further below*. The IP address preset in the scanner can be changed of course. All you need (in this case) is not love, but a Web Browser. The procedure is given in the M2-iLAN manuals. For quick help call the MEL hotline.

On customers request, MEL delivers Scanners configured with „custom“ IP addresses. When you have a sticker on your scanner, you could be almost 95% sure that the sticker specifies the pre-set IP address. Without a sticker, the IP address should be the factory default address.

- M2-iLAN Laser Scanner Standard-IP Address: 192.168.123.245 Scanner and PC must be in the same subnet. For details on network configuration see the MEL network tutorial or M2-iLAN manual.

When MEL already made an installation of the MelTrax software on your system you could leave out the following steps. If not, continue with check of the network settings.

- the trick with the secondary network address:

- ➡ in properties TCP/IP4 click the button „Extended“. (red mark in the upper Screenshot). The screen as shown left opens. Click on „add“ and enter a new IP-Address, then click OK.

MelTrax Software Manual

4. Enter IP-address in MelTrax

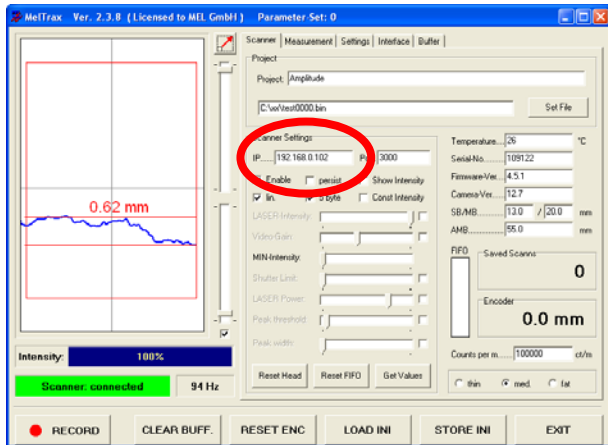

Your screen should look now like at left side.

- enter the IP-address of the Scanners at the red marked place. Leave the port address at 3000.
- click on another place or press enter to make MelTrax aware, that you changed the IP-address.

If you have connected your Scanner already to the network and power supply, MelTrax will immediately contact the Scanner and start to display the profile. The Scanner- Status bar in the lower left of the screen will become green and show „Scanner: connected“.

■ Use multiple instances of MelTrax software

Switches

When you want to use more than one Scanner you should use an Ethernet-Switch. Hubs do not work, and 100Mbit switches are available for 10 ... 20 €. We recommend 100Mbit switches, because they make less trouble and even the cheapest models provide automatic recognition of cable polarity. This function saves you a lot of trouble.

M2-iLAN Scanner do not generate so much data: in a 100Mbit network you could use 64 Scanner, and the network will still not be overloaded. Therefore you must not use Gigabit switches, even when you use a couple of scanners. Cheap switches have one big advantage: they have no configuration to be set up. In highly sophisticated industry switches, we found that these may have configuration of metric set to a firm frame size. If so, set it to “auto”, and it will work.

Auto MDI must be on, if not already set so. Network cards of cheap laptops still tend to have no Auto MDI feature (automatic recognition of cable polarity) and thus give problems. If you have no switch, in such a case you would need a “crossover network cable” to reach the scanner. If the M12-connector at the scanner is a screw-on type, you could exchange the Rx- and Tx- wires at the connector to make the connection work. Still the easiest and quickest solution: connect a switch...

Law and order

Place every instance of the MelTrax Software in an own folder. MelTrax must be able to store its *.ini files in an own folder, to prevent that *.ini files get over written by another instance. If you erase an *.ini file, that should not be a real problem: MelTrax regenerates the ini file, if it is not “there” at next start. Of course, the new *.ini file will be made with all default settings, and this may be unusable for the task you have to do;- ok Houston,- we have a small problem! You could now use a “cold spare” (a backup of the file saved in a separate folder) to cure the default values which were not ideal for your task. Preset values and all parameter set up values are given in the Xconfig.ini File. Details are shown in the last part of the manual.

The number of MelTrax Software instances is not limited, but every instance of MelTrax must be unlocked separately. You may shift unlocked instances of the MelTrax Software on the same PC to another folder without leaving the license. We have not tested, if MelTrax can run in virtual machines.

- Each instance of MelTrax Software communicates with exactly one M2-iLAN Laser-Scanner. You need to install as much MelTrax Software instances as M2-Scanners. If you use more than one Scanner, make sure you use *different* IP-addresses for the scanners.

Unlock MelTrax

- Start MelTrax
- Check connection to the Scanner
- Click the Tab „Register“
- Click on „request“
- Copy the string in your e-mail client and send it to : mail@MELSensor.de
- please add reference information (customers name, serial number and order- or Proforma number)! Within a short time you will receive the unlocking string. Copy the unlock string to the field unlock and click the button „unlock“.
- The Register Tab disappears and MelTrax is unlocked.
- Your custom Logo can be imported into MelTrax software: create a Logo as bitmap file with the size of 432x91 pixels place it in the folder where start.exe is located. The screenshot shows how MelTrax will present your Logo.

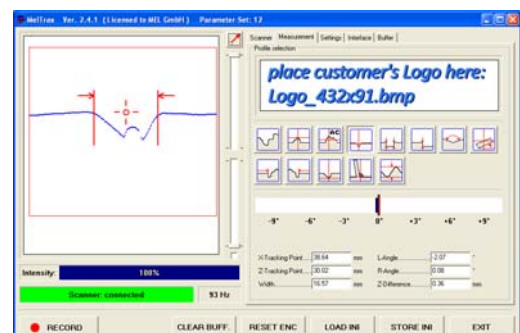

MelTrax Software Manual

MelTrax Clients, upbringing and care

Set up IP-address in MelTrax Client



In the MelTrax *Client* the IP-address must be set up. The IP address depends from the fact if the *Client* is running on the same PC as MelTrax, or on another PC in the network.

use MelTrax Clients on the same PC: IP-address 127.0.0.1 = "localhost"
 use MelTrax Clients on another PC: IP-address of the MelTrax-PC



for connection, server and client must be in one subnet of the network: the IP addresses of client and MelTrax PC must be equal, except the last three digits. Identical IP addresses are not allowed to be used, this may cause a lot of trouble! When Client and MelTrax run on the same PC and the connection is made with the *localhost*, per definition of network standards, both are in the same subnet.

Connect : manual or automatic

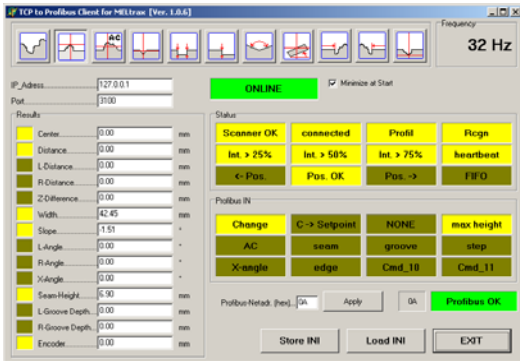

The MelTrax Profibus Client connects automatically to the preset IP address. The same applies to Analog Client and Display Client. These Clients do not have a button "Connect".

With the TCP_Test_Client (current Rev.1.2.2) the situation is different. The TCP Client has a „Connect“ button, and the network connection is activated only after clicking this button.

The reason is historic: the TCP Client has been meant as a maintenance client. The connection should be made only when requested to avoid unnecessary network traffic.

Client	Connect is made ...
TCP Client 1.2.2	manual
Profibus Client	automatic
Analog Client	automatic
Display Client	automatic
Relay Client	automatic
NG Client	automatic
Selection Client	automatic

Other custom specific clients:

UT Client special version of Profibus client
 Welotec Client special version of Relay client

Converter

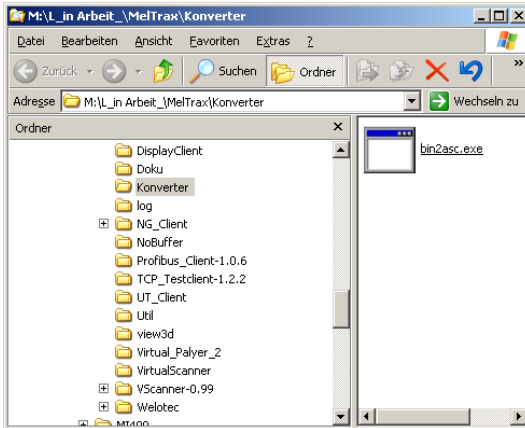

The "Bin to ascii Konverter" converts a recorded scan profile data file (*.scan) to a readable text format (*.txt).

Drag the test file with the mouse to the bin2asc.exe icon, and the converter starts working.

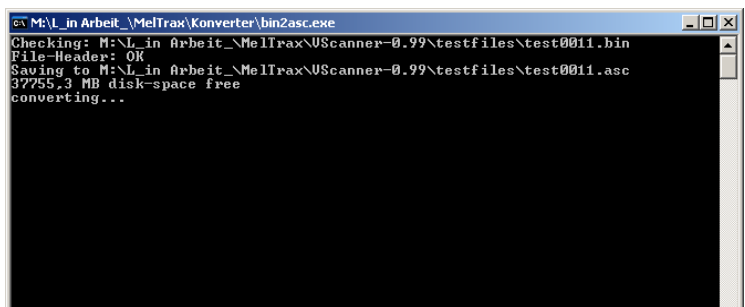

The converted files are stored in the source directory. The converter creates a header with 5 columns: index, Y-Pos[mm], X-Pos[mm], Z-Pos[mm], Intensity. You can import the ascii files in a calculation Software like Microsoft Exel.



The intensity values have been encoded in 4 Bit in earlier hardware versions. Since hardware version 3, we changed to 8 Bit. For legacy hardware Scanner, the intensity values should be converted to 8 Bit representation. The *Virtual Player2* has the option "Intensity 4-8 Bit Wandlung für legacy M2D-Scanner Rev 1..3".



The following is an example on the next page is the representation of a converted scan data file.

We have cut out some lines in the print to save space.

After index 282, the index counter starts again from 0. Then the second profile is sent, which has the profile points interleaved with the first profile. The index count starts at 0, so in total MelTrax uses 283 profile points. The Scanner delivers 290 profile points, MelTrax cuts some points at the edges.

More details are given in the M2-iLAN manual.

MelTrax Software Manual

File-Format-Converter ver. 1.0.0

Original File: M:\L_in Arbeit_\MelTrax\VScanner-0.99\testfiles\test0011.bin

Date: 13.04.2010

Time: 16:19:42

Scan-width: 80,000

Measurement-range: 120,000

Beginning of measurement-range: 84,000

Encoder-pulses per meter: 10000

Max. X / Z / I: 4095 / 4095 / 255

File-Info-Text: -----

Project: Amplitude

Software: Ver. 2.2.4

Laser Intensity : AUTO niveau=82

Min. Intensity : 0

Demarcation : -10000

Video-Gain : -10400

Peak_Threshold : -10005

Peak_Width : -10000

Firmware Ver. 4.6.0

Camera Ver. 12.7

File-Info-Text-End-----

Index	Y-Pos[mm]	X-Pos[mm]	Z-Pos[mm]	Intensity					
0	0,000	1,250	94,945	226	258	0,000	80,000	120,029	1
1	0,000	1,524	94,945	238	259	0,000	80,000	120,029	1
2	0,000	1,797	95,033	254	260	0,000	80,000	120,029	1
3	0,000	2,071	95,062	254	261	0,000	80,000	120,029	1
4	0,000	2,344	95,062	238	262	0,000	80,000	120,029	1
5	0,000	2,618	95,238	223	263	0,000	80,000	120,029	1
6	0,000	2,891	95,267	223	264	0,000	80,000	120,029	1
7	0,000	3,165	95,267	224	265	0,000	80,000	120,029	1
8	0,000	3,419	95,414	229	266	0,000	80,000	120,029	1
9	0,000	3,692	95,355	232	267	0,000	80,000	120,029	1
...					268	0,000	80,000	120,029	1
31	0,000	9,768	95,326	185	269	0,000	80,000	120,029	1
32	0,000	10,042	95,326	154	270	0,000	80,000	120,029	1
33	0,000	10,315	95,297	152	271	0,000	80,000	120,029	1
34	0,000	10,589	95,267	160	272	0,000	80,000	120,029	1
35	0,000	10,862	95,209	160	273	0,000	80,000	120,029	1
36	0,000	11,155	95,179	142	274	0,000	80,000	120,029	1
37	0,000	11,448	95,121	143	275	0,000	80,000	120,029	1
38	0,000	11,722	95,121	138	276	0,000	80,000	120,029	1
39	0,000	11,995	95,062	130	277	0,000	80,000	120,029	1
40	0,000	12,405	92,513	43	278	0,000	80,000	120,029	1
41	0,000	12,542	94,945	116	279	0,000	80,000	120,029	1
42	0,000	12,816	94,886	92	280	0,000	80,000	120,029	1
43	0,000	13,109	94,799	110	281	0,000	80,000	120,029	1
44	0,000	13,382	94,769	120	282	0,000	80,000	120,029	1
45	0,000	13,656	94,769	109	0	0,000	1,387	94,945	230
46	0,000	14,066	92,103	47	1	0,000	1,661	94,974	239
47	0,000	14,222	94,564	73	2	0,000	1,934	95,033	254
48	0,000	14,613	92,103	44	3	0,000	2,208	95,062	254
49	0,000	14,769	94,535	89	4	0,000	2,481	95,121	241
50	0,000	15,199	91,546	41	5	0,000	2,755	95,238	224
51	0,000	15,473	91,194	40	6	0,000	3,028	95,267	222
....					7	0,000	3,302	95,267	225
254	0,000	80,000	120,029	1	8	0,000	3,556	95,355	227
255	0,000	80,000	120,029	1	9	0,000	3,829	95,414	236
256	0,000	80,000	120,029	1	10	0,000	4,122	95,414	234
257	0,000	80,000	120,029	1	11	0,000	4,396	95,414	232

MelTrax Software Manual

Configuration

Important settings are kept in the two ini-Files *xconfig.ini* and *EthernetScanner.ini*. Parameters of the ini Files are listed below. Changing to the ini files may affect the system. Changes could render the system to a non-working condition. Values may represent -10.xxx where xxx is the standard parameter. Example: when instead of 128 -10.128 is received, the parameter is disabled, yet preset for future use. Deactivated parameters can be activated in the GUI.

Xconfig.ini

[General]	Default	Remarks
Path	-	Define the path for saving recorded files
Project	-	Defines the project name for saving recorded files
Auto Enable	1	1 = enable scanner automatic 0 = enable scanner manually
Start_Prg	3	Nr. of algorithm active after start
EncoderCounts/m	10.000	Value depends from encoder in use
Thickness	1	Thickness of profile display [Pixel] 0= thin 1 = middle 2 = thick
Enable_16bit Status	1	Set 0 only for legacy hardware
Enable_OSK	1	Enable on screen keyboard
Simple_GUI	0	= 1: show only scan profile window / restricted display
Window_Top	0	Position of evaluation window
Window_Left	0	Position of evaluation window
Window_Height	400	Position of evaluation window
Window_Width	400	Position of evaluation window
Language	1	0= nglisch 1 = deutsch
Parameter_Set	0	default
Company	-	Company name for registration
Key	-	- is set with the registration -
[Settings]	Default	
SchwelleMin_1	0	Coordinate of evaluation window
SchwelleMax_1	4095	Coordinate of evaluation window
Min_X_1	0	Coordinate of evaluation window
Max_X_1	4095	Coordinate of evaluation window
Pivot_X	0	
Pivot_Z	0	
Rot_Angle	0	
Min-Height	0.3	
X-Setpoint	12.00	Center X = zero point or reference for result output X
Z-Setpoint	0	
Width-Setpoint	5	
Width-Tolerance	1	
Reference Slope	0	
Reference 2_Edge_Angle	0	
Center-Hysteresis	1	Hysteresis for position left right signal
Groove-Offset	0	Correction value
Left_Gap-Level	0.5	Threshold for seam tracking
Right_Gap-Level	0.5	Threshold for seam tracking
Filter_Depth	1	Filter setting – see text
Search_Depth	12	Filter setting – see text
Appx_Degree	6	Filter setting – see text
Max_Slope °	20	Maximum slope angle
Min_Side_Length	15	Minimum length of Profile at the side
Left_Angle	60	Left angle – only for v-shape
Right_Angle	60	Right angle – only for v-shape
[Interface]	Default	
TCP_Port	3100	The sending port for clients
Interface_Enable	1	
Profibus_Enable	0	Set to 1 to activate data transfer to Profibus client.
Profibus_Adress	10	
[Options]	Default	
Noise_Reduction	0	Filter setting – see text
S-Filter	0	Filter setting – see text
Smoothing	0	Filter setting – see text
Force_to_V-Shape	0	Filter setting – see text
P-Plausibility	0	Filter setting – see text
S-Plausibility	0	Filter setting – see text
Double_Side_Search	0	Filter setting – see text
Show_Center	1	Show the cross hair cursor
Show_Width	0	Display the width
Filter	0	Inter-Scan-Filter (number of Scans, average)
Show_Evaluation_Window	0	Display of evaluation window
Show_Depth	0	Display of groove depth
Local_Video	1	Switch on graphic display on / off
Minimize_at_Start	0	Minimize screen to taskbar after start
Show_Centerline	0	Display center line
Show_Setpoint_Area	0	Display set point area
Low_Performance	0	Save performance

MelTrax Software Manual

Show_C/W_in_Groove	0	Show center and width
Show_Slope_Adjust_Marker	0	Tool for slope adjustment
Distance_on_Edge	1	Alternative option for highest point and min height
Show_2_Edge_Marker	0	Tool for slope adjustment
Check_Width	0	Seam width is compared to seam width value +/- tolerance
Center_on_Edge	0	Tracking point coordinates are calculated from the edges
Z_Mirror	0	The profile is mirrored in the vertical axis
[Custom Values]	Default	Parameter No. Function
Center	0	0 Tracking Point coordinate x
Distance	0	1 Tracking Point coordinate z
L-Distance	0	2 Left distance
R-Distance	0	3 Right distance
Z-Difference	0	4 Height difference
Width	0	5 Width of seam / groove
Slope	0	6 Slope angle (averaged)
L-Angle	0	7 Left angle
R-Angle	0	8 Right angle
X-Angle	0	9 Included angle above the profile
Seam_Height	0	10 Seam height
L-Groove_Depth	0	11 Left groove depth
R-Groove_Depth	0	12 Right groove depth
Encoder	0	13 Encoder [mm]
Status	0	14 Software-Status (siehe Text)
[Marker]	Default	
P_X_1		
P_Y_1		
P_X_2		
P_Y_2		
P_X_3		
P_Y_3		
P_X_4		
P_Y_4		
[Buffer]	Default	
Buffer_Mode	3	
LP_Buffer_Size	2000	
Y_Direction	0	
Y_Interpolation	0	
Display_Buffer	1	
Auto_Clear_Invalid_Frames	100	
Auto_Clear_Buffer	0	
Filter_Enable	1	
Operating_Distance	1	Distance between scan line and output; depending on the selection scaled in mm or seconds / scanner coordinates – see text
Operating_Delaytime	10	
Filter_Enable_0	0	Set to 1 to activate the filter
Range_Display_X_min_0	-5	
Range_Display_X_max_0	5	
Filter_Appx_Degree_0	10	
Rebuild_Appx_Degree_0	10	
Rebuild_Filter_Width_0	1	
Min_Step_Rcgn_0	1	
Filter_Enable_1	1	
Range_Display_X_min_1	-5	
Range_Display_X_max_1	5	
Filter_Appx_Degree_1	10	
Rebuild_Appx_Degree_1	10	
Rebuild_Filter_Width_1	1	
Min_Step_Rcgn_1	1	
Filter_Enable_2	0	
Range_Display_X_min_2	-5	
Range_Display_X_max_2	5	
Filter_Appx_Degree_2	10	
Rebuild_Appx_Degree_2	10	
Rebuild_Filter_Width_2	1	
Min_Step_Rcgn_2	1	
Filter_Enable_3	0	
Range_Display_X_min_3	-5	
Range_Display_X_max_3	5	
Filter_Appx_Degree_3	10	
Rebuild_Appx_Degree_3	10	
Rebuild_Filter_Width_3	1	
Min_Step_Rcgn_3	1	
Filter_Enable_4	0	
Range_Display_X_min_4	-5	
Range_Display_X_max_4	5	
Filter_Appx_Degree_4	10	

MelTrax Software Manual

Rebuild Appx Degree 4	10	
Rebuild Filter Width 4	1	
Min Step Rcg 4	1	
Filter Enable 5	0	
Range Display X min 5	-5	
Range Display X max 5	5	
Filter Appx Degree 5	10	
Rebuild Appx Degree 5	10	
Rebuild Filter Width 5	1	
Min Step Rcg 5	1	
Filter Enable 6	0	
Range Display X min 6	-5	
Range Display X max 6	5	
Filter Appx Degree 6	10	
Rebuild Appx Degree 6	10	
Rebuild Filter Width 6	1	
Min Step Rcg 6	1	
Filter Enable 7	0	
Range Display X min 7	-5	
Range Display X max 7	5	
Filter Appx Degree 7	10	
Rebuild Appx Degree 7	10	
Rebuild Filter Width 7	1	
Min Step Rcg 7	1	
Filter Enable 8	0	
Range Display X min 8	-5	
Range Display X max 8	5	
Filter Appx Degree 8	10	
Rebuild Appx Degree 8	10	
Rebuild Filter Width 8	1	
Min Step Rcg 8	1	
Filter Enable 9	0	
Range Display X min 9	-5	
Range Display X max 9	5	
Filter Appx Degree 9	10	
Rebuild Appx Degree 9	10	
Rebuild Filter Width 9	1	
Min Step Rcg 9	1	
Filter Enable 10	1	
Range Display X min 10	-5	
Range Display X max 10	5	
Filter Appx Degree 10	10	
Rebuild Appx Degree 10	10	
Rebuild Filter Width 10	1	
Min Step Rcg 10	1	
Filter Enable 11	0	
Range Display X min 11	-5	
Range Display X max 11	5	
Filter Appx Degree 11	10	
Rebuild Appx Degree 11	10	
Rebuild Filter Width 11	1	
Min Step Rcg 11	1	
Filter Enable 12	0	
Range Display X min 12	-5	
Range Display X max 12	5	
Filter Appx Degree 12	10	
Rebuild Appx Degree 12	10	
Rebuild Filter Width 12	1	
Min Step Rcg 12	1	

EthernetScanner.ini

[Settings Scanner 1]	
Scanner_IP=192.168.123.245	TCP/IP Address of the scanners
Scanner_Port=3000	Scanner Port default = 3000
CCDAnfangBereich=0	Camera data
CCDEndeBereich=96	Camera data
LASER_Intensity=0	Laser Intensity
Video_Gain=0	Video gain
MIN_Intensity=0	Minimum intensity
LASER_Niveau=0	
Peak_Threshold=0	
Peak_Width=0	
ConstIntensity=0	
Protokoll_Version=3	Protocol Version 1,2,3 for LAN Scanner are supported

MelTrax Software Manual

Files, which have been created using the function „*Configuration Set No. Save*“ have the progra number in the name.

For each Configuration set or parameter set two files were created:
Xconfigxxxx.ini and EthernetScannerxxxx.ini.



In the Xconfig.ini file all pre set values and parameter are saved, therefore the Xconfig File is relatively big. The content of the Eth_Scanner000003.ini is pictured on the right side, it is a small file.

```
[Settings_Scanner_1]
Scanner_IP=192.168.0.100
Scanner_Port=3000
CCDAnfangBereich=4
CCDEndeBereich=88
LASER_Intensity=-10000
Video_Gain=-10400
MIN_Intensity=1
Demarcation=-10000
LASER_Niveau=-10095
Peak_Threshold=-5
Peak_Width=-10000
ConstIntensity=0
Protokoll_Version=3
```

The Xconfig00003.ini is bigger, find an example on the next page.

You need not to know all the details in your ini files. You should just know where your ini files are located, just in case the MEL hotline ask you to send a copy of the ini file for analysis of a problem. If you send the ini file, we know how your software is set up and we could probably understand your problem better.

Also, ini files can be prepared „offline“. This may allow to set up the ini file and just feeding the ini file to your MelTrax may teach the application to work better. The command „Load Config Set No.“ can load such ini files.

MelTrax Software Manual

Xconfig000003.ini -> Configuration-Set No. 3

```
[General]
Path=X:\Projekte_SVN\Virtual_Scanner\N
eenah_Gessner\test0000.bin
Project=Test
Company=Nadeesh Wizards
Key=05606D6E0829652F740D721703147
77C3D1D18371861265D1A17557D1E531
F6D6819377B
EncoderCounts/m=100000
Auto Enable=1
Start_Prg=3
Thickness=1
Enable_16bit_Status=1
Enable_OSK=1
Simple_GUI=0
Window_Top=236
Window_Left=607
Window_Height=468
Window_Width=575
Language=0
Parameter_Set=3
[Settings]
Min-Height=0.05
X-Setpoint=18.178281525944
Z-Setpoint=41.4508604469244
Center-Hysteresis=1
Groove-Offset=0
Left_Gap-Level=0.5
Right_Gap-Level=0.5
Filter_Depth=2
Search_Depth=5
Appx_Degree=10
Max_Slope=70
Min_Side_Length=12
Left_Angle=60
Right_Angle=60
SchwelleMin_1=290
SchwelleMax_1=3888
Min_X_1=304
Max_X_1=3880
S-Setpoint=5
Reference Slope=53.6235377196594
Reference      2_Edge_Angle=-
42.17470824163
Width-Setpoint=5
Width-Tolerance=5
ZoomFaktor=5
Pivot_X=51.7264023227343
Pivot_Z=53.6442318186086
Rot_Angle=10.6403905684946
[Interface]
TCP_Port=3100
Interface_Enable=1
Profibus_Enable=0
Profibus_Adress=10
[Options]
Noise_Reduction=0
S-Filter=0
Smoothing=0
Force_to_V-Shape=0
P-Plausibility=0
S-Plausibility=0
Double_Side_Search=1
Show_Center=1
Show_Width=1
Filter=0
Show_Evaluation_Window=1
Show_Depth=1
Local_Video=1
Minimize_at_Start=0
Show_Centerline=1
Show_Setpoint_Area=0
Low_Performance=1
Show_C/W_in_Groove=1

Show_Slope_Adjust_Marker=0
Distance_on_Edge=1
Show_2_Edge_Marker=0
Check_Width=0
Center_on_Edge=0
Z_Mirror=0
Invert_X=0
Invert_Z=0
Rotate_Scan=0
Auto_Rotate=0
[Custom Values]
Center=1
Distance=1
L-Distance=1
R-Distance=1
Z-Difference=1
Width=1
Slope=1
L-Angle=0
R-Angle=0
X-Angle=0
Seam_Height=0
L-Groove_Depth=0
R-Groove_Depth=0
Encoder=0
Status=1
[Marker]
P_X_1=1642
P_Y_1=2559
P_X_2=547
P_Y_2=1568
P_X_3=3665
P_Y_3=1982
P_X_4=2453
P_Y_4=2714
[Buffer]
Buffer_Mode=0
Filter_Enable=1
Rebuild_Filter_Depth=0
Rebuild_Appx_Degree=1
Rebuild_Filter_Width=1
Operating_Distance=1
Operating_Delaytime=2
Display_Buffer=1
Filter_Appx_Degree=1
Y_Direction=0
Range_Display_X_min_0=-2
Range_Display_X_max_0=2
Filter_Appx_Degree_0=10
Rebuild_Appx_Degree_0=10
Rebuild_Filter_Width_0=1
Range_Display_X_min_1=-5
Range_Display_X_max_1=5
Filter_Appx_Degree_1=10
Rebuild_Appx_Degree_1=10
Rebuild_Filter_Width_1=1
Range_Display_X_min_2=-10
Range_Display_X_max_2=10
Filter_Appx_Degree_2=0
Rebuild_Appx_Degree_2=0
Rebuild_Filter_Width_2=1
Range_Display_X_min_3=-10
Range_Display_X_max_3=10
Filter_Appx_Degree_3=0
Rebuild_Appx_Degree_3=0
Rebuild_Filter_Width_3=1
Range_Display_X_min_4=-10
Range_Display_X_max_4=10
Filter_Appx_Degree_4=0
Rebuild_Appx_Degree_4=0
Rebuild_Filter_Width_4=1
Range_Display_X_min_5=-10
Range_Display_X_max_5=10
Filter_Appx_Degree_5=0
Rebuild_Appx_Degree_5=0
Rebuild_Filter_Width_5=1
Range_Display_X_min_6=-10
Range_Display_X_max_6=10
Filter_Appx_Degree_6=0
Rebuild_Appx_Degree_6=0
Rebuild_Filter_Width_6=1
Range_Display_X_min_7=-10
Range_Display_X_max_7=10
Filter_Appx_Degree_7=0
Rebuild_Appx_Degree_7=0
Rebuild_Filter_Width_7=1
Range_Display_X_min_8=-10
Range_Display_X_max_8=10
Filter_Appx_Degree_8=0
Rebuild_Appx_Degree_8=0
Rebuild_Filter_Width_8=1
Range_Display_X_min_9=-10
Range_Display_X_max_9=10
Filter_Appx_Degree_9=0
Rebuild_Appx_Degree_9=0
Rebuild_Filter_Width_9=1
Range_Display_X_min_10=0
Range_Display_X_max_10=30
Filter_Appx_Degree_10=5
Rebuild_Appx_Degree_10=5
Rebuild_Filter_Width_10=1
Range_Display_X_min_11=-10
Range_Display_X_max_11=10
Filter_Appx_Degree_11=0
Rebuild_Appx_Degree_11=0
Rebuild_Filter_Width_11=1
Range_Display_X_min_12=-10
Range_Display_X_max_12=10
Filter_Appx_Degree_12=0
Rebuild_Appx_Degree_12=0
Rebuild_Filter_Width_12=1
Filter_Enable_0=1
Filter_Enable_1=1
Filter_Enable_2=0
Filter_Enable_3=0
Filter_Enable_4=0
Filter_Enable_5=0
Filter_Enable_6=0
Filter_Enable_7=0
Filter_Enable_8=0
Filter_Enable_9=0
Filter_Enable_10=1
Filter_Enable_11=0
Filter_Enable_12=0
Min_Step_Rcgn_0=1
Min_Step_Rcgn_1=1
Min_Step_Rcgn_2=1
Min_Step_Rcgn_3=1
Min_Step_Rcgn_4=1
Min_Step_Rcgn_5=1
Min_Step_Rcgn_6=1
Min_Step_Rcgn_7=1
Min_Step_Rcgn_8=1
Min_Step_Rcgn_9=1
Min_Step_Rcgn_10=1
Min_Step_Rcgn_11=1
Min_Step_Rcgn_12=1
Y_Interpolation=0
LP_Buffer_Size=2000
Auto_Clear_Invalid_Frames=100
Auto_Clear_Buffer=0
```

MelTrax Software Manual

Connect MEL- Hardware

M2-iLAN scanner models do not have a separate electronic box. The connections are at the scanner head. Please read scanner manual for details.



LED's	Function display
Power	24 V Power OK
Eth.-Link	Network access (blinking)
100Mbit	Network OK
System	Controller OK (blinking)
FPGA	Status OK



When the ETH.-Link-LED does not blink quickly (3..5 Hz), then the network connection between scanner and PC is not active. Windows should produce a *balloon info* when the network starts building up connection. When the software is active, a few seconds later, the Eth.-Link LED should start blinking. When the scanner is connected and network active, MelTrax should display „Scanner connected“ in green.

Definition of measurement

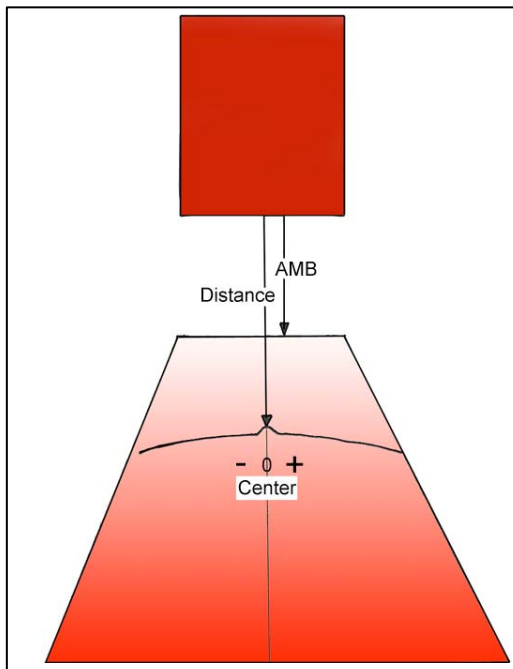

Tracking point and Setpoint



Definition of the Scanners view

The polarity of the MelTrax output is in relation to the coordinate system of the scanner: look from the camera side, so that the camera is looking the same direction as the viewer. Under this condition, the following definition is valid:

- movement to the right = + [positive sign]
- movement to the left = - [negative sign]
- the virtual centre is in the centre of the Scan range x.

MelTrax software references signal polarity depending on the viewing direction of the scanner. The picture on the left refers to the view in the view direction of the camera.

- Please note that the technical drawings for the M2-iLAN Scanners are using opposite viewing direction. See the drawing below!



Adjust the Setpoint; Zero point for tracking applications

Before adjusting the software, adjust your torch (tool) mechanically to be in the best position, then adjust the scanner to be in a symmetrical position to the groove; check the groove position in the profile display window. The command button "Centre to Setpoint" will then set the offset to match exactly the position.

How to proceed:

1. Mechanically adjust Scanner and torch over the groove
2. Set up algorithm and display options
3. When cursor position is stable click "Centre to Setpoint"
4. → Centre value is set to +0.00
5. Click "STORE INI" to write the settings to the ini file.

- *Setpoint should be approximately half of Scan range SBE in x.*

during adjustment of Setpoint the object shall not move!

Scaling of the axis

The scaling of M2-Scanner in x-axis is defined in reference to the lower side of the x axis, SBE. In our example with the M2-iLAN-80/40/55 this is 55 mm. Centre of the range = 27.5 mm.

The scaling of the z-axis is defined in reference to Range MB. The scales of the axis are divided in 4096 increments (0...4095).

Scaling the x-axis: the value of the given profile point is $(x[\text{digital value}] / 4095) * X[\text{SBE}]$ in mm

The digital value of the profile points does not always start at zero, and may not reach 4095. In the upper part of the scan window, the x-axis is narrower than at bottom.



Absolute values of scaling

According to the drawing above, the zero point of digital data is the lower right edge of the profile window. All coordinates are given in the scanner coordinate system.

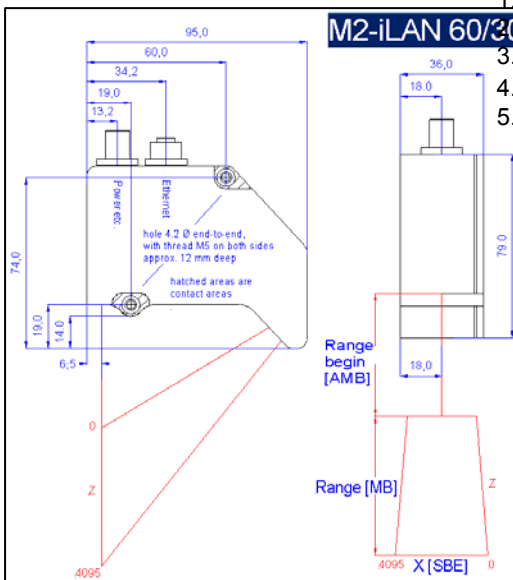

MelTrax Software Manual

Variations of Hardware- and Software Configuration of MelTrax

Software could use different hardware revisions of M2-LaserScanners in a flexible way as pointed out in the following examples:

■ MelTrax software with LAN- (BlueBox Rev. 3) or M2-iLAN-Scanner (Rev. 4)

The M2-iLAN- or M2-LAN- Laser Scanner is connected over a network connection. MelTrax Software reads data over Ethernet-Network (TCP) from the IP-Address of the Scanner. Each instance of MelTrax software reads one scanner. If you are using two scanners, launch MelTrax twice, if you are using three scanners launch it three times. MelTrax may be active on *any* PC in the network, and it is not important on which PC it is active.

2. MelTrax software with VScanner, iControl + M2D-Scanner (legacy Rev. 2+)

Legacy M2D Scanners with connection to the iControl may be used with MelTrax through the help of VScanner.exe. The VScanner software must be installed on the iControl. Please note, that VScanner requires giveio.sys driver to be installed and active in the Windows XP operating system, for details see **page 42**.

MelTrax Software *could* be active on the same iControl together with VScanner, receiving data over the localhost; and it *could* be as well connected to a PC in the network.

■ MelTrax software with MelTrax Clients

Various clients are available as add-ons (Apps) for MelTrax Software. While MelTrax receives data from the Scanner, makes filtering and evaluation, the clients care about connecting to the outer world. This includes the connection to PLC and display of results

The names of the clients describe their Functions:

Profibus Client	Measurement result and status to Profibus
Relay Client	Measurement result (as ok / Not ok) and status to Digital I/O
TCP Client	Remote control and "maintenance" over network
Welotec Client	Position control for 2 Scanners
Display Client	Display measurement results
Analog Client	Output 0 ... 10 V (for iControl only) – 4 analog outputs

more clients are in preparation.

Data communication to MelTrax clients

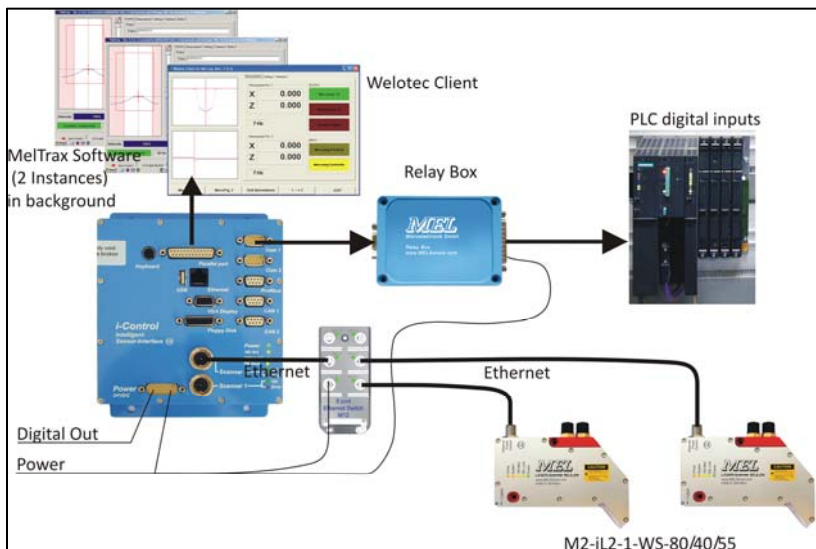

Possible arrangement of a dual M2-iLAN-Scanner head arrangement with MelTrax and iControl.

The custom specific relay client works with the serial RS-232 interface. The relay client inputs and outputs go to digital I/O of the PLC.

Communication to the PLC could be made with Profibus or over TCP / Ethernet as described in the S7-project.

The graphs on the next pages show the data path for various combinations of MelTrax, hardware and clients:

1. example is given for a legacy M2D-Scanner connected to the iControl with VScanner.
2. example is given for M2-iLAN Scanner in the network.
3. example is given for M2-iLAN Scanner in the network, MelTrax and clients on different PC's (localhost).

Customer specific clients

When you have requirements which are not fulfilled with the existing MelTrax clients, then notify MEL about your requirement. MEL will analyze the requirements and propose a solution. Of course, MelTrax is not the only software package we provide...

MelTrax Software Manual

Example 1 : VScanner : M2D- Scanner + iControl +localhost + TCP Client

How legacy hardware M2D Scanners with iControl can be connected to MelTrax software

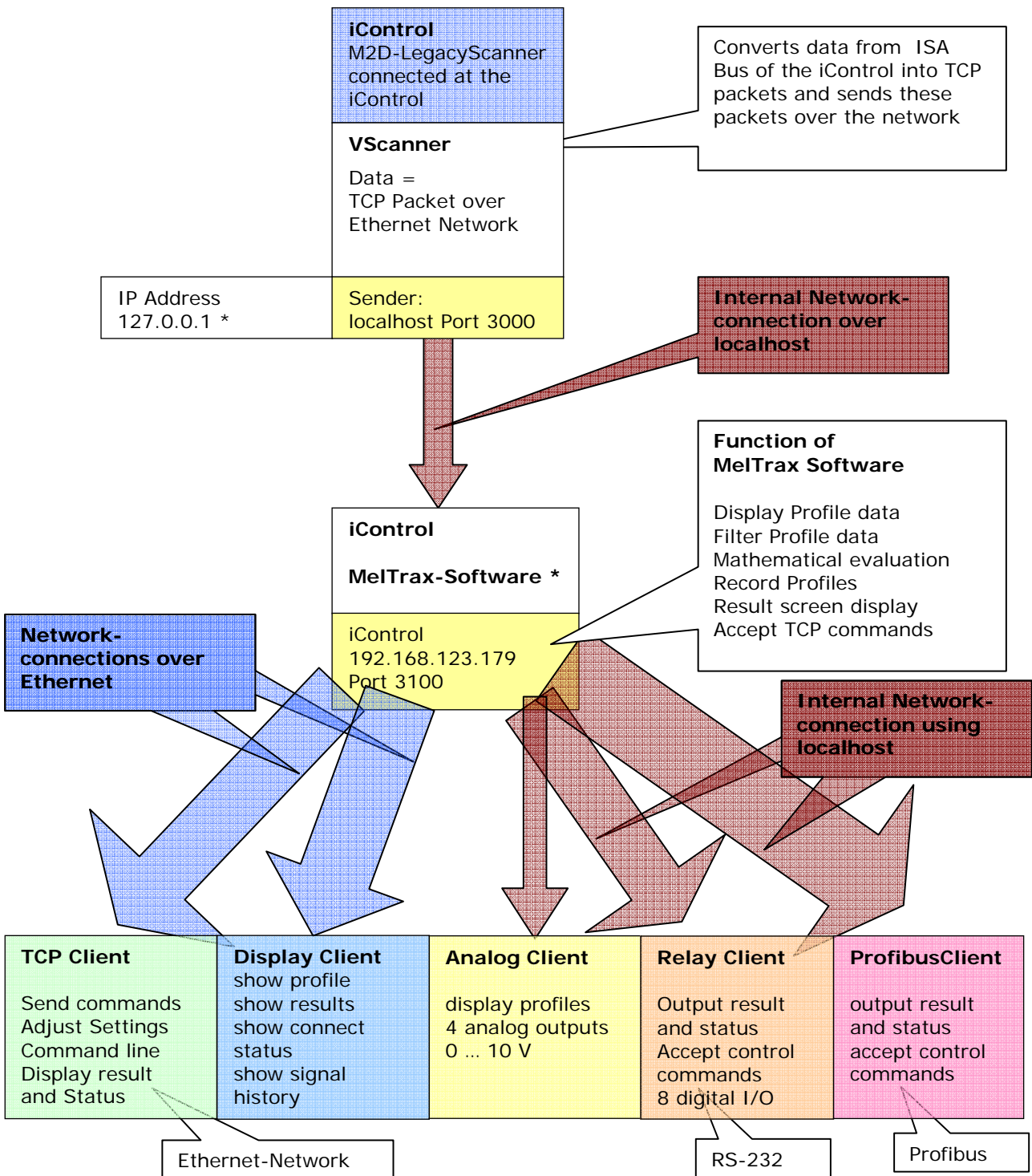

* IP Address and Port of the sender must be set at the receiving MelTrax software
 Sender and receiver must be in the same Subnet!
 ** Additional clients have the same Port Address
 Several clients can be active at the same time.

MelTrax Software Manual

Example 2 : M2-iLAN Scanner + network PC + MelTrax + Clients

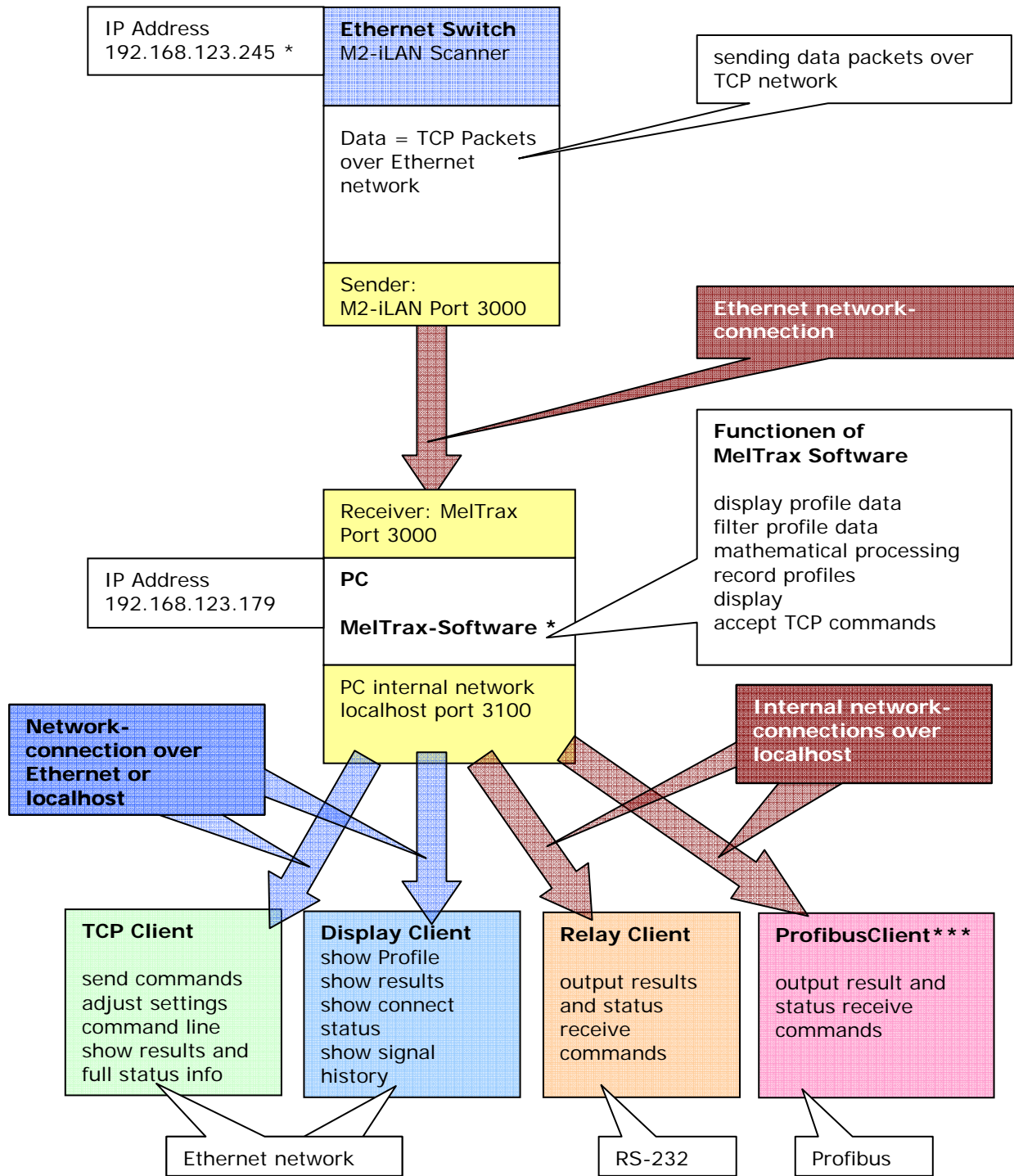

* IP address and port of the sender must be registered in the MelTrax Software
 Sender and receiver must be in the same subnet!
 ** Other clients can be connected through the same ports.
 Several clients can be connected at the same time
 *** Special Profibus Client for PC

MelTrax Software Manual

Example 3 : M2- iLAN Scanner + PC + MelTrax + localhost + Clients

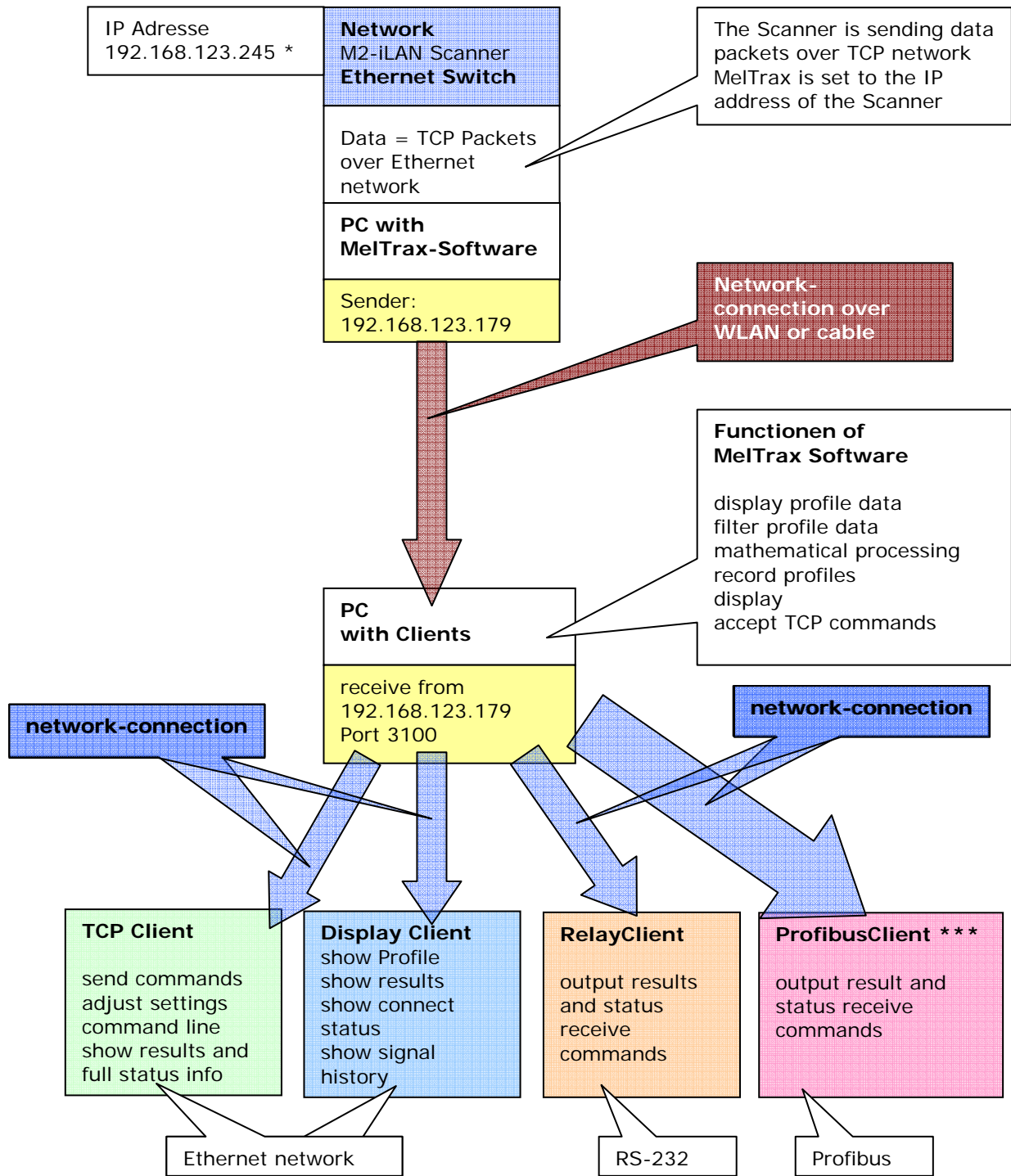

* IP address and port of the sender must be registered in the MelTrax Software
Sender and receiver must be in the same subnet!

** Other clients can be connected through the same ports.
Several clients can be connected at the same time

*** Special Profibus Client for PC

MelTrax Software Manual

EFW driver

Function: the EWF-Treiber diverts all write attempts under Windows XP to the RAM.

Required files:

- Installation_EWF_E.txt
- ewf.sys
- ewfapi.dll
- ewfdll.dll
- ewfmgr.exe
- ewfntldr

make sure, that Windows Pagefile under System Properties|Advanced|Performance|Virtual Memory is switched off.

Command	File	Target
Copy	ewf.sys	C:\Windows\system32\drivers
	ewfapi.dll	C:\Windows\system32
	ewfdll.dll	C:\Windows\system32
	ewfmgr.exe	C:\Windows\system32

Rename Ntldr in C:\ into Ntldr.old
Copy Ewfntldr to C:\ and rename it into Ntldr

Start Regedit (Start->run regedit)

Select the registry key

- HK_Local_Machine
- System
- CurrentControlSet
- Enum
- Root

And select with right mouse click Permissions...

under Group or User names select Everyone

and set Fullcontrol Allow

confirm with the button Apply

do not close or quit Regedit!

- open ewf.reg (Double click) and confirm
- remove Fullcontrol Allow and confirm with the button Apply

Close Regedit **now**

Open Start -> Run

ewfmgr c: -enable and ENTER

The EWF-Treiber is activated at next restart: restart your PC.

Form now on all write attempts will be diverted to the RAM.

Switch off EWF driver temporarily

If you want to save the write attempts diverted to RAM to disk, you need to do the following:

Open Start -> Run

ewfmgr c: -commit and ENTER

with the next shutdown, all changes to the system will be written to the disk.

After restart, the EWF driver is active again.

MelTrax Software Manual

Parameters in use by algorithm number

Name	Meaning	Remarks	Active at Algorithm Nr.
Setpoint x ; z	X- / Z-coordinate for "zero" of Tracking point		1 ... 10
Min. Height	Threshold for recognition (below Min = no recognition)		1,2,10
Hysteresis	"dead" zone for 2-point regulator		1 ... 10
Calib_Gv_Offset	calibration offset for groove depth measurement		4,5
Left Gap Level	Recognition level for left edge		3,4,5,8,9
Right Gap Level	Recognition level for right edge		3,4,5,8,9
Filter depth	Overlay filter for Scan profiles		3,4,5,8,9
Search Depth	Number of Scans for correction signal		1 ... 10
Search appx	Approximation degree for correction signal		1 ... 10
Max Slope	Max slope for recognition		3,4,5,8,9
Min. Side Length	Min profile side length in Pixels for recognition		3,4,5,8,9,10
Left Angle	Left profile set angle	Active at Force to V	3,4
Right Angle	Right profile set angle	Active at Force to V	3,4
Slope Setpoint	Set value for slope (Slope Adjust Marker)		3,4,5,8,9,10
Noise Reduction	Noise filter		3,4,5
S-Filter	Band filter for scan profile (Parameter not adjustable)	Cut sharp edges	3,4,5
Smooth	Low pass Filter for Scan profile		3,4,5
Force To V-Shape	Profile is forced to V shape 12, 13		3,4,5
P-Plausibility Check	Plausibility control for border recognition	Par. Not changeable	3,4,5
S-Plausibility Check	Plausibility control for edge recognition	Par. Not changeable	3,4,5
DSS	Double-Side-Search holes and buckles were searched		3,4,5
Distance on Edge	Z-Position is anchored with measurement program Nr. 10 at the side borders		10

Changes and additions by software version

Version	New features	Function
1.2.4	Activate Video Refresh	Switch off graphic display; this saves CPU load
1.2.4	Minimize at Start	Saves CPU load
1.2.5	TP/W in Groove	Display the width or groove depth
1.2.6	Show Centerline	Display cross hair cursor
1.3.0	VScanner	Client for connection to legacy M2D-Scannern at the iControl File Player for recorded scan data files
1.3.0	Low Performance Mode	Reduces CPU load
1.3.4	Distance on Edge	Calculate the tracking z coordinate from the seam / profile edges
1.3.5	Edge L / R + Tiefster Punkt	Algorithms for left / right tracking including „deepest point“
1.3.5	Record TCP Befehl	Remote record command
2.0.0	Slope Adjust Marker	Adjustment tool for slope adjustment
2.1.0	2. Slope Adjust Marker	Adjustment tool for slope adjustment
2.1.1	Fillet weld	Algorithm for fillet weld
2.1.9	Amplitude	Display of profile min-max amplitude
2.2.0	Simple Gui	Display of Simple Gui=1 in the ini-File
2.2.0	Display Client	Display of measurement results
2.2.2	Z Mirror	Mirror the profile in the Z-Axis
2.2.4	Invert-X, Invert-Z	Invert the sign of the output signals
2.3.1	SE privilegien	Set SE privileges
2.3.2	Signal zu links zu rechts	Position signals inverted with Invert-x
2.3.3	Rotate Scan, Auto Rotate	Rotate scan profile
2.3.4	Reset Epot Scanner	Reset scanner settings to default
2.3.7	Reverse extrapolation	Plausibility check, reverse extrapolation, Clear Buffer extended
2.3.8	Configuration Set No	Define a set of program configuration and store it
	Auto Clear Buffer	Auto clear buffer, when the number of invalid profiles has been reached
	DB	Write a Debug File for analysis and diagnose
	Display Client mit Zoom	Display 4 selected parameters
2.4.1	Selection client	Quickly change program sets
	Switch language	Change language by definition in the ini file
	Custom logo	Import custom logo on the main page
2.4.2	SCSSG; SCSNG	Command added: Switch simple GUI on and off from remote client